

GUSTAV WOLF

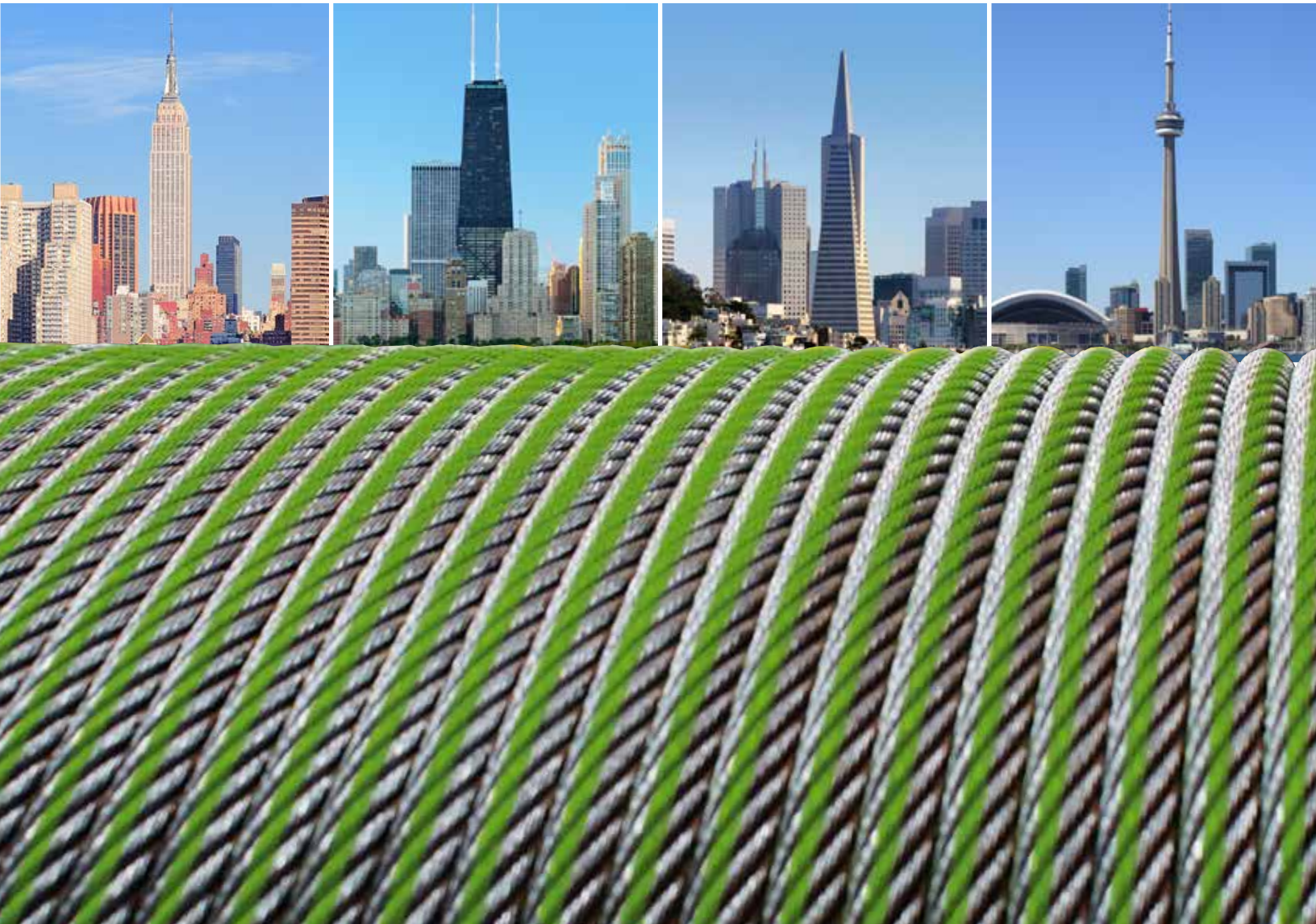

Elevator Ropes and Accessories for North America

5th Edition

Table of Contents

General Information

Note on New Ropes and Existing Sheaves	1
Codes and Standards	1
Replacement Criteria (ASME A17.1/CSA B44 and A17.6)	1 - 4
Ordering	5
Handling, Tensioning and Surface Line	6
Wire Rope Installation	7
Wedge Socket Installation	8
Re-lubrication	9

Wire Rope

Selection Guide for Imperial Diameters	10
Imperial Diameters for Standard Applications	11
Imperial Diameters for Special Applications	12
Metric Diameters	13 - 15
Metric Diameters with Electrical Conductors	15

Wire Rope Accessories

Wedge Sockets and Wedge Socket Components	16 - 17
Babbitt Sockets	17
Lubricants and Oilers	18
Reeving Splices, Cable Bands and Rope Clips	18
Selector/Door Cable	18

Wire Rope Tools

Tension Measuring	19 - 20
Diameter Measuring	20
Cutting	20

In 2012 Gustav Wolf, headquartered in Germany, celebrated its 125th anniversary and is widely recognized as one of the world's most important producers of steel wire ropes for elevators. Today, with six factories in five countries, we offer a full line of elevator wire ropes designed and manufactured to meet the requirements of the elevator industry worldwide.

Our product line for elevator ropes includes imperial and metric diameters in natural and synthetic fiber core, PAWO F3 und PAWO F7 steel-reinforced natural fiber core, PAWO F7S and PAWO 819W full steel core, PAWO F10 nine-strand full steel core, TopTrac™ nine-strand full steel core in double-parallel lay, CompactTrac™ compacted-strand natural fiber core, PowerTrac™ compacted-strand full steel core and PAWO F4e and PAWO F5e synthetic fiber core galvanized ropes with electrical conductor(s) for use on outdoor maintenance platforms and similar applications.



New Wire Ropes and Existing Sheaves

IT IS STRONGLY RECOMMENDED that the sheaves of existing elevators be carefully checked and re-grooved or replaced as necessary prior to rope replacement.

The diameter of the new ropes is greater than that of the old ropes and failure to bring the sheave grooves into the machine manufacturer's specified tolerances can lead to vibration, metal shavings and other problems.

Codes and Standards

- 1) The **ASME A17.1b-2009/CSA B44b-09** code permits the use of steel wire suspension (hoist) and governor ropes with a minimum diameter of 9.5 mm (0.375 in). The minimum permitted D/d ratio for suspension (hoist) ropes is 40:1 and for governor ropes is per ASME A17.1b-2009/CSA B44b-09 2.18.7.4. This code establishes a minimum D/d ratio of 32:1 for, but does not restrict the diameter of steel wire compensating ropes. For suspension (hoist), governor and compensating ropes this code also specifies minimum factors of safety.
- 2) The **ASME A17.1-2010/CSA B44-10** code (last revised in 2013) and **ASME A17.6-2010** standard permit the use of steel wire suspension (hoist) ropes with a minimum diameter of 4.0 mm (0.156 in) and steel wire governor ropes

with a minimum diameter of 6.0 mm (0.25 in). The minimum permitted D/d ratio for suspension (hoist) ropes is 40:1 and for governor ropes is per ASME A17.1-2010/CSA B44-10 2.18.7.4. This code establishes a minimum D/d ratio of 32:1 for, but does not restrict the diameter of steel wire compensating ropes. For suspension (hoist), governor and compensating ropes this code also specifies minimum factors of safety.

- 3) Local code always takes precedence regarding minimum rope diameters, D/d ratios, factors of safety, etc. Refer to the code/standard document applicable in your jurisdiction or contact your Gustav Wolf representative for additional information.

Replacement Criteria

The replacement criteria for steel wire ropes fall into four categories

For more details, see **ASME code/standard excerpts below** (the applicable code/standard differs by jurisdiction and therefore we have listed both ASME A17.1b-2009/CSA B44b-09 and ASME A17.6-2010 information in this catalog - local code always takes precedence).

- 1) **Crown breaks:** The crown wires are those that make contact with the sheave and they will show signs of abrasion. If enough abrasion and/or rope fatigue due to bending takes place, the crown wires will break. When using this criterion, an inspector is looking for the number of total crown wire breaks within a rope lay. A rope lay is approximately 6.5 times the diameter of the rope. For example, the rope lay for 3/8 in • 9.5 mm ropes is

2.44 in • 62 mm, for 1/2 in • 12.7 mm ropes is 3.25 in • 83 mm and for 5/8 in • 15.9 mm ropes is 4.06 in • 103 mm.

- 2) **Valley breaks:** The valley wires are located in the valleys of two adjacent strands. They do not make contact with the sheave and therefore should not experience abrasion. Valley breaks are attributed to rope fatigue due to bending.
- 3) **Diameter reduction:** If the ropes reach a specified diameter reduction, they should be replaced even if no crown or valley breaks are present.
- 4) **Red dust or rouge:** The existence of red dust, or rouge, is also a factor in determining rope replacement.

Excerpts from ASME A17.1b-2009/CSA B44b-09, Part 8

8.11.2.1.3(cc) Wire Suspension and Compensating Ropes

8.11.2.1.3(cc)(1) Wire suspension and compensating ropes shall be replaced:

- (a) if the broken wires are equally distributed among the strands, when the number of broken wires per rope lay in the worst section of the rope exceeds the values shown in column A of Table 8.11.2.1.3(cc)(1); or
- (b) if the distribution of the broken wires is unequal, and broken wires predominate in one or two strands, when the number of broken wires per rope lay in the worst section of the rope exceeds the values shown in column B of Table 8.11.2.1.3(cc)(1); or
- (c) if four or five wires, side by side, are broken across the crown of any strand, when the number of broken wires per rope lay in the worst section of rope exceeds values shown in column C of Table 8.11.2.1.3(cc)(1); or
- (d) if in the judgment of the inspector, any unfavorable condition, such as fretting corrosion (red dust or rouge), excessive wear of individual wires in the strands, unequal tension, poor sheave grooves, etc., exists, the criteria for broken wires will be reduced by 50% of the values indicated in Table 8.11.2.1.3(cc)(1) for any of the three conditions described above; or
- (e) if there is more than one valley break per rope lay.

Table 8.11.2.1.3(cc)(1) Wire Suspension and Compensation Ropes

Types of Wire Rope	A*	B*	C*
6x19 class (6 strands w/ 16-26 wires/strand)	24-30	8-12	12-20
8x19 class (8 strands w/ 16-26 wires/strand)	32-40	10-16	16-24

*The upper limits may be used when inspections are made monthly by a competent person.

8.11.2.1.3(cc)(2) On winding drum machines, the ropes shall be replaced:

- (a) if the broken wires are equally distributed among the strands, when the number of broken wires per rope lay in the worst section of rope exceeds 12 to 18; or
- (b) if wire breaks predominate in one or two strands, when the number of broken wires per rope lay in the worst section of rope exceeds 6 to 12; or
- (c) if there is more than one valley break per rope lay.

Replacement Criteria

Excerpts from ASME A17.1b-2009/CSA B44b-09, Part 8 continued

8.11.2.1.3(cc)(3) On any type of elevator, the suspension, compensation and governor ropes shall be replaced when their actual diameter is reduced below the value shown in Table 8.11.2.1.3(cc)(3):

Table 8.11.2.1.3(cc)(3)

Nominal Size inches	Maximum Reduced Diameter inches • decimal inches
3/8	11/32 • 0.344
7/16	13/32 • 0.406
1/2	15/32 • 0.469
9/16	17/32 • 0.531
5/8	37/64 • 0.578
11/16	41/64 • 0.641
3/4	45/64 • 0.703
1	15/16 • 0.938

8.6.3.2 Replacement of a Single Suspension Rope

If one rope of a set is worn or damaged and requires replacement, the entire set of ropes shall be replaced, except, where one rope has been damaged during installation or acceptance testing prior to being subjected to elevator service, it shall be permissible to replace a single damaged rope with a new rope, provided that the requirements of 8.6.3.2.1 through 8.6.3.2.6 are met.

8.6.3.2.1 The wire rope data for the replacement rope must correspond to the wire rope data specified in 2.20.2.2(a), (b), (c), (f), and (g) for the other ropes.

8.6.3.2.2 The replacement rope shall be provided with a wire rope data tag conforming to 2.20.2.2.

8.6.3.2.3 The suspension ropes, including the damaged rope, shall not have been shortened since their original installation.

8.6.3.2.4 The diameter of any of the remaining ropes shall not be less than the nominal diameter minus 0.4 mm (0.015 in.).

8.6.3.2.5 The tension of the new replacement rope shall be checked and adjusted as necessary at semi-monthly intervals over a period of not less than two months after installation. If proper equalization of rope tension cannot be maintained after six months, the entire set of hoist ropes shall be replaced.

8.6.3.2.6 The replacement rope shall be provided with the same type of suspension-rope fastening used with the other ropes.

8.6.3.3 Replacement of Ropes Other than Governor Ropes

8.6.3.3.1 Replacement of all ropes, except governor ropes (see 8.6.3.4) shall conform to the following:

(a) Replacement ropes shall be as specified by the original elevator manufacturer or be at least equivalent in strength, weight, and design.

(b) Ropes that have been previously used in another installation shall not be reused.

(c) When replacing suspension, compensating, and car or drum counterweight ropes, all ropes in a set shall be replaced, except as permitted by 8.6.3.2.

(d) The ropes in the set shall be new, all from the same manufacturer, and of the same material, grade, construction, and diameter.

NOTE: ASME A17.1/CSA B44 does not require that the ropes be from the same master reel/production run.

(e) Data tags conforming to 2.20.2.2 shall be applied.

(f) Suspension, car, and drum counterweight rope fastenings shall conform to 2.20.9.

8.6.3.4 Replacement of Governor or Safety Rope

8.6.3.4.1 Governor ropes shall be of the same size, material, and construction as the rope specified by the governor manufacturer, except that a rope of the same size but of different material or construction shall be permitted to be installed in conformance with 8.7.2.19.

8.6.3.4.2 The replaced governor ropes shall comply with 2.18.5.

8.6.3.4.3 After a governor rope is replaced, the governor pull-through force shall be checked as specified in 8.11.2.3.2(b).

8.6.3.4.4 A test tag indicating the date when the pull-through test was performed shall be attached.

NOTE: Some in the industry believe that all ropes for an installation must be cut from the same master reel/production run. This is not stated in ASME A17.1/CSA B44.

When using a caliper to measure wire rope, measure from crown to crown...

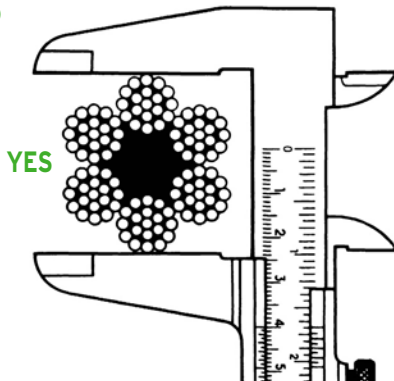

...and not from valley to valley.

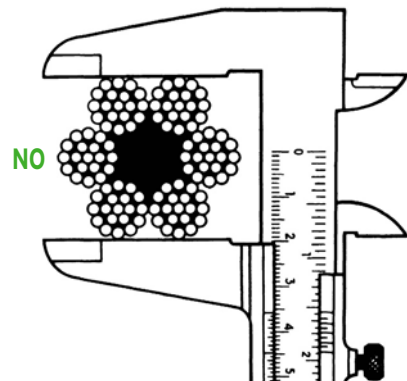

Replacement Criteria

Excerpts from ASME A17.6-2010, Section 1.10

Notes:

- (1) Replacement criteria for steel wire rope are based on the worst conditions of diameter and wire breaks. Crown wires are subject to both wear that reduces the diameter of the rope and the breaks that occur in the wear area. Breaks that are visible and occur outside of the crown wear area with the crown wire intact are called valley breaks.
- (2) Where ropes are subjected to reverse bends or where ropes are installed on nonmetallic sheaves or sheaves with nonmetallic liners or inserts, extra attention must be given to the rope due to possible acceleration of valley breaks.

1.10.1 Traction Drive Machines

1.10.1.1 Replacement requirements for steel wire suspension ropes for traction elevators shall be as follows (see Nonmandatory Appendix A):

- (a) The steel wire rope(s) shall be replaced if the rope is permanently kinked, bent, or deformed in any way (see 1.10.5).
- (b) For rope diameters equal to or greater than 8 mm (0.315 in.), the ropes shall be replaced in accordance with 1.10.1.2(a) through 1.10.1.2(g) and 1.10.3.
- (c) For rope diameters less than 8 mm (0.315 in.), the ropes shall be replaced in accordance with 1.10.1.2(a) through (g), 1.10.1.2.1 and 1.10.1.2.2, and 1.10.3. In addition, other replacement criteria based on the application shall be permitted to be applied. The replacement criteria shall be documented in the Maintenance Control Program (see ASME A17.1/CSA B44, requirement 8.6.1.4.1).

1.10.1.2 Criteria for replacement include at least one of the following:

- (a) if the broken crown wires are equally distributed among the strands, when the number of broken wires per rope lay in the worst section of rope exceeds the values shown in the "Normal Wear Conditions," first column of Table 1.10.1.2-1
- (b) if the distribution of breaks is unequal and broken crown wires predominate in one or two strands, when the number of broken wires per rope lay in the worst section of rope or the minimum diameter exceeds the values shown in the "Normal Wear Conditions," first column of Table 1.10.1.2-1
- (c) if four wires, side by side, are broken across the crown of any strand, when the number of broken wires per rope lay in the worst section of rope exceeds the values shown in the "Normal Wear Conditions," first column of Table 1.10.1.2-1
- (d) if an unfavorable condition exists, such as but not limited to corrosion due to external conditions, excessive wear of individual wires in the strands, unequal tension, poor sheave grooves; the criteria for broken crown wires shall be the values indicated in the "Unfavorable Wear Conditions," second column of Table 1.10.1.2-1 for any of the conditions described above
- (e) if red dust or rouge exists, the criteria for broken wires shall be the values indicated in the "Rope Showing Rouge," third column of Table 1.10.1.2-1 for any of the conditions described above
- (f) if there is more than one valley break per rope lay
- (g) if there are any valley breaks at any location where rouge exists.

1.10.1.2.1 The elevator manufacturer using information from the rope manufacturer and considering the application, shall establish the design life limit to ensure that the residual strength of wire ropes less than 8 mm (0.315 in.) diameter is not less than 60% of the minimum breaking force at the time of replacement.

1.10.1.2.2 Steel wire ropes of less than 8 mm (0.315 in.) in diameter shall be replaced when there is evidence of rouge.

Table 1.10.1.2-1 Wire Breaks: Crown Wire Breaks Per Lay Length

6-Strand Rope Applications	Normal Wear Conditions	Unfavorable Wear Conditions	Ropes Showing Rouge
<i>Distributed breaks (max.)</i>	24	12	12
<i>Unequal breaks (max.)</i>	8	4	4
<i>4 Side-by-Side breaks</i>	12	6	6

8- and 9-Strand Rope Applications	Normal Wear Conditions	Unfavorable Wear Conditions	Ropes Showing Rouge
<i>Distributed breaks (max.)</i>	32	16	16
<i>Unequal breaks (max.)</i>	10	5	5
<i>4 Side-by-Side breaks</i>	16	8	8

GENERAL NOTES:

- (a) Where ropes are subjected to reverse bends or where ropes are installed on nonmetallic coated, plastic, fiber-reinforced plastic sheaves or sheaves with nonmetallic liners or inserts, extra attention must be given to any steel wire rope (6, 8, or 9 strand) due to possible acceleration of valley breaks.
- (b) This table does not apply to Winding Drum Machines. See 1.10.2 for replacement criteria.
- (c) No more than one valley break per lay length and no valley breaks allowed if visible rouge.
- (d) For ropes less than 8 mm, also see 1.10.1.2.2 for additional replacement requirements.

1.10.2 Winding Drum Machines

Suspension ropes shall be replaced on winding drum machines if:

- (a) the broken crown wires are equally distributed among the strands, when the number of broken wires per rope lay in the worst section of rope exceeds 12;
- (b) the broken crown wires predominate in one or two strands, when the number of broken wires per rope lay in the worst section of rope exceeds 6;
- (c) there is more than one valley break per rope lay; or
- (d) there are any valley breaks at any location where rouge exists

1.10.3 All Elevator Types

The suspension, compensation, and governor ropes shall be replaced when their actual diameter is reduced below the value shown in Table 1.10.3-1 (see next page). For nominal diameters not listed in Table 1.10.3-1, the minimum diameter reduction shall be calculated using the criteria outlined in General Notes (a) and (b) of Table 1.10.3-1. Normal wear diameters, unfavorable wear, and rouge conditions as listed in the table shall apply. Compensation and governor ropes shall also conform to 1.10.1.1(a) and 1.10.1.2(a) through 1.10.1.2(g).

Replacement Criteria

Excerpts from ASME A17.6-2010, Section 1.10 continued

Measurement for diameter shall be taken on a straight portion of rope at the worst location. Two measurements at the same position at right angles shall be taken. The ropes shall be replaced if both of these measurements are below the replacement value. However, if only one of the measurements is below the replacement value, then the criteria for wire breaks under "Unfavorable Wear Conditions" shall apply. See Table 1.10.1.2-1.

1.10.4 Replacement of Ropes

Replacement of all ropes, except governor ropes (see ASME A17.1/CSA B44, requirement 8.6.3.4), shall conform to the requirements of 1.10.4.1 through 1.10.4.6.

1.10.4.1 Replacement ropes shall be as specified by the original elevator manufacturer or be at least equivalent in strength, weight, and design.

1.10.4.2 Ropes that have previously been installed and used on another installation shall not be reused.

1.10.4.3 When replacing suspension, compensating, and car or drum counterweight ropes, all ropes in a set shall be replaced, except as permitted by 1.10.5.

1.10.4.4 The ropes in the set shall be new, all from the same manufacturer and of the same material, grade, construction, and diameter.

NOTE: ASME A17.6 does not require that the ropes be from the same master reel/production run.

1.10.4.5 Data tags conforming to ASME A17.1/CSA B44, requirement 2.20.2.2 shall be applied.

1.10.4.6 Suspension, car, and drum counterweight rope fastenings shall conform to ASME A17.1/CSA B44, requirement 2.20.9.

1.10.5 Replacement of a Single Suspension Rope

If one rope of a set is worn or damaged and requires replacement, the entire set of ropes shall be replaced; except, where one rope has been damaged during installation or acceptance testing prior to being subjected to elevator service, it shall be permissible to replace a single damaged rope with a new rope provided that the requirements of 1.10.4.4 and 1.10.5.1 through 1.10.5.1.6 are met. NOTE: Damage includes but is not limited to kinked ropes.

1.10.5.1 The steel wire rope data for the replacement rope must correspond to the steel wire rope data specified in ASME A17.1/CSA B44, requirement 2.20.2.2.

1.10.5.2 The replacement rope shall be provided with a data tag conforming to ASME A17.1/CSA B44, requirement 2.20.2.2.

1.10.5.3 The suspension ropes, including the damaged rope, shall not have been shortened since their original installation.

1.10.5.4 The diameter of any of the remaining ropes shall not be less than the nominal diameter minus 0.4 mm (0.015 in.).

1.10.5.5 The tension of the new replacement rope shall be checked and adjusted as necessary at semi-monthly intervals over a period of not less than 2 months after installation. If proper equalization of the rope tension cannot be maintained after 6 months, the entire set of suspension ropes shall be replaced.

1.10.5.6 The replacement rope shall be provided with the same type of suspension rope fastening used with the other ropes.

NOTE: Some in the industry believe that all ropes for an installation must be cut from the same master reel/production run. This is not stated in ASME A17.6.

**Table 1.10.3-1 Imperial Minimum Diameter
6-, 8-, and 9-Strand Rope Applications**

Nominal Rope Size	Normal Wear Conditions	Unfavorable Wear Conditions	Ropes Showing Rouge
1/4 in.	0.242 in.	0.242 in.	Note (1)
5/16 in.	0.303 in.	0.303 in.	Note (1)
3/8 in.	0.352 in.	0.352 in.	0.363 in.
7/16 in.	0.410 in.	0.410 in.	0.424 in.
1/2 in.	0.469 in.	0.469 in.	0.484 in.
9/16 in.	0.527 in.	0.527 in.	0.545 in.
5/8 in.	0.586 in.	0.586 in.	0.605 in.
11/16 in.	0.645 in.	0.645 in.	0.666 in.
3/4 in.	0.703 in.	0.703 in.	0.727 in.
13/16 in.	0.762 in.	0.762 in.	0.787 in.
7/8 in.	0.820 in.	0.820 in.	0.848 in.
15/16 in.	0.879 in.	0.879 in.	0.908 in.
1 in.	0.938 in.	0.938 in.	0.969 in.
1 1/8 in.	1.055 in.	1.055 in.	1.090 in.
1 1/4 in.	1.172 in.	1.172 in.	1.211 in.
1 3/8 in.	1.289 in.	1.289 in.	1.332 in.
1 1/2 in.	1.406 in.	1.406 in.	1.453 in.

**Table 1.10.3-1 Metric Minimum Diameter
6-, 8-, and 9-Strand Rope Applications**

Nominal Rope Size	Normal Wear Conditions	Unfavorable Wear Conditions	Ropes Showing Rouge
4 mm	3.875 mm	3.875 mm	Note (1)
5 mm	4.844 mm	4.844 mm	Note (1)
6 mm	5.813 mm	5.813 mm	Note (1)
6.5 mm	6.297 mm	6.297 mm	Note (1)
6.7 mm	6.491 mm	6.491 mm	Note (1)
8 mm	7.500 mm	7.500 mm	7.750 mm
9 mm	8.438 mm	8.438 mm	8.719 mm
10 mm	9.375 mm	9.375 mm	9.688 mm
11 mm	10.31 mm	10.31 mm	10.66 mm
12 mm	11.25 mm	11.25 mm	11.63 mm
13 mm	12.19 mm	12.19 mm	12.59 mm
14 mm	13.13 mm	13.13 mm	13.56 mm
15 mm	14.06 mm	14.06 mm	14.53 mm
16 mm	15.00 mm	15.00 mm	15.50 mm
18 mm	16.88 mm	16.88 mm	17.44 mm
19 mm	17.81 mm	17.81 mm	18.41 mm
20 mm	18.75 mm	18.75 mm	19.38 mm
22 mm	20.63 mm	20.63 mm	21.31 mm

GENERAL NOTES:

(a) Maximum allowable diameter reduction below nominal for rope diameters less than 8 mm is 3.125%.

(b) Maximum allowable diameter reduction below nominal for rope diameters equal to or greater than 8 mm are as follows:

(1) Normal wear or unfavorable wear conditions is 6.25%. (2) Ropes showing rouge is 3.125%.

NOTE: (1) For ropes less than 8 mm, the rope must be replaced if rouge is evident. See 1.10.1.2.2.

Ordering

Ordering hoist ropes

The information needed to order hoist ropes is the number (quantity), length and diameter of the ropes; the stranding, construction and lay; the grade or tensile strength; and the breaking force (load or strength). While this information may be provided on the wire rope tag, it should be noted that the tag information may not always be accurate; it is not uncommon to find that the wrong tag has been applied. Use the following procedure for ordering hoist ropes for a traction elevator:

- 1) **Count the number of ropes on the elevator.**
- 2) **Determine the length of each rope.** The length can often be found on the installation layout.
- 3) **Measure the diameter of the rope.** If you don't have a measuring tool, the crosshead data plate on top of the car should show the diameter or the diameter may be stamped on the existing shackles.
- 4) **Determine the stranding and construction of the rope.** Stranding is the number of strands per rope and the number of wires per strand (e.g. an 8-strand rope with 19 wires per strand has 8 x 19 stranding). Determine whether the rope has 6, 8 or 9 strands by looking at the shackles where the stranding is more easily seen. The rope construction (Seale, Warrington, Filler Wire, etc.) can be found by matching up the rope cross-section with the cross-sections shown in this catalog.
If there is not a crosshead data plate and the building is over 50 years old, the ropes used are usually 6 x 25 Filler Wire with Right Regular lay (most 6-strand hoist ropes are of this construction). An 8-strand hoist rope is usually 8 x 19 Seale. Lay can vary (see Step 5 below).

- 5) **Determine the lay of the rope.** Compare a Right Regular lay rope to a Right Lang lay rope:

Right Regular



Right Lang



Note that the orientation of the individual wires is parallel to the centerline in a Right Regular lay rope. Right Regular lay is assumed if the lay is not indicated on your order.

- 6) **Determine the grade or tensile strength of the rope.** In North America, grades are commonly expressed as Iron, Traction or Extra High Strength Traction (EHST).

Iron rope is normally used for governor and compensation ropes.

Traction rope can be used for hoist, governor and compensation applications.

Extra High Strength Traction (EHST) rope is frequently specified for high-rise/high-speed hoisting conditions.

Grade is sometimes expressed as tensile strength in Newtons/square millimeter (N/mm²) or pounds/square inch (psi).

For help in selecting the correct grade, see the table on page 10 for information on rope type, wire tensile strength and sheave hardness.

- 7) **Determine the breaking force**, which can aid in confirming the grade and is usually indicated on the crosshead data plate. For example, if a breaking load of 14,500 lbf • 64,500 N is indicated for 1/2 in • 12.7 mm 8 x 19 ropes, refer to the information in this catalog or call your Gustav Wolf representative for the correct grade (in this case, traction grade).

Other considerations:

- 1) **Core:** The purpose of the core is to provide support for the strands. Natural fiber is the most common core used in elevator ropes in North America. However, in some high-rise/high-speed, most MRL and certain hydraulic applications, the use of steel-reinforced or full steel core

(IWRC) ropes is becoming more common. Contact your Gustav Wolf representative for more information.

- 2) **Preforming:** In the preforming process, the strands are formed into a helix (spiral) prior to closing. Preformed rope is the industry standard and provides longer service life while being easier to handle. All the ropes in this catalog are preformed.
- 3) **Coating:** Bright (uncoated) is the industry standard and comes without any coating on the rope other than lubrication. For protection from weather and corrosion (e.g. outdoor and mine elevators), the use of a galvanized coating is often recommended. Gustav Wolf 3/8 in • 9.5 mm, 1/2 in • 12.7 mm and 5/8 in • 15.9 mm 8 x 19 Seale galvanized hoist/governor ropes in traction grade are in stock for immediate delivery. See page 12 for details.
- 4) **Compacted strands:** A rope design with flattened wires/strands to increase contact area, reduce surface pressure and help to extend rope service life associated with rope fatigue due to reverse bends (e.g. basement machines). See page 12 for details.
- 5) **Stretch/Elongation:** Elevator wire rope stretch results from two main factors. **Elastic** stretch is an increase in rope length due to increase in load (as load increases, the rope becomes longer and narrower and vice versa). **Constructional** stretch is an increase in rope length due to the settling/compression of the core and strands when a load is applied (most occurs shortly after the rope is put into service). Ropes made by different manufacturers and ropes of different strandings, constructions, grades, etc. exhibit different stretch characteristics. For more information on wire rope stretch refer to page 10 of this catalog or contact your Gustav Wolf representative.
- 6) **Prestretching:** Some wire rope manufacturers promote pre-stretched rope at a premium price. Laboratory testing has shown that standard Gustav Wolf natural fiber core rope exhibits comparable elongation to commonly used brands of pre-stretched fiber core rope without the associated increase in price. Contact your Gustav Wolf representative for more information on Gustav Wolf low-stretch natural fiber core wire rope.

Ordering governor and compensation ropes

The ordering procedure is similar to hoist ropes but you may have to rely on the rope tag to a greater degree because there is no crosshead data plate for governor or compensation ropes. However:

- 1) **Measure the diameter of the rope.** Use a caliper, micrometer or Go/No Go gauge (available on page 20 of this catalog).
- 2) **Go to the shackles and confirm the stranding of the rope.** Compare your rope to the rope cross-sections shown in this catalog. Almost all compensation and governor ropes have 8 strands.
Look at the rope tag to determine breaking force and then refer to the information in this catalog or contact your Gustav Wolf representative for the correct grade (Iron or Traction).
- 3) **Consider the rope grade or tensile strength.** Governor and compensation ropes are either Iron or Traction - never Extra High Strength Traction (EHST).
- 4) **Confirm the lay of the rope.** Governor and compensation ropes are always Right Regular lay and never Right Lang lay.

Other considerations:

- 1) Preformed rope is always preferred for its longer life and ease of installation.
- 2) Replace all governor and compensation ropes with preformed ropes.

Handling, Tensioning and Surface Line

Handling of wire ropes prior to and during installation

- 1) Reels are best transported on the job site by rolling on a clean flat surface or by lifting from a pipe in the reel center hole.
- 2) Wire rope should be stored indoors, off the ground and covered to protect it from moisture, dirt, dust, sunlight, etc.
- 3) Care must be taken to unroll and not laterally pull wire rope when paying it off the reel. Kinking and dragging ropes over sharp edges must be avoided.
- 4) Ropes must be prevented from rotating during installation since free-hanging ropes will untwist under their own weight. The use of reeving splices is recommended and these are available on page 18.
- 5) Loose rope ends should always be seized or secured with cable bands to prevent untwisting. Cable bands are available on page 18.
- 6) The installers should continually inspect wire rope during installation to identify any areas which may have been damaged in shipment or while in storage on the job site. Per ASME A17.1b-2009/CSA B44b-09 8.6.3.2 and ASME A17.6-2010 1.10.5, where one suspension rope has been damaged during installation or acceptance testing prior to being subjected to elevator service, it shall be permissible to replace a single damaged rope with a new rope, provided that the requirements of 8.6.3.2.1 through 8.6.3.2.6 and 1.10.4.4 and 1.10.5.1 through 1.10.5.6 respectively are met.

Wire rope may be payed off a reel supported by jack stands with a helper using a board as a brake...

YES

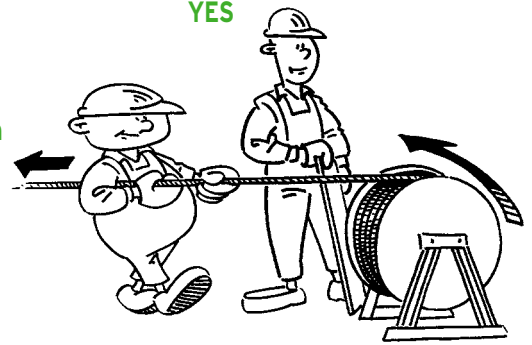

...or by paying it off a coil as the helper rotates it...

YES

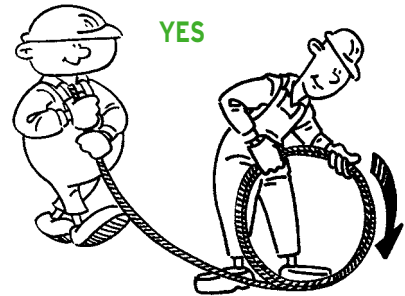

...or by paying it off a bollard as the helper rotates it.

YES

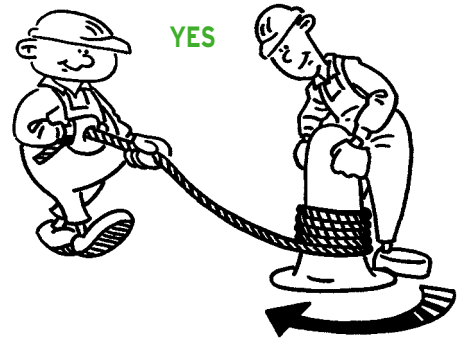

Tensioning of hoist ropes

ASME A17.1-2010/CSA B44-10 8.6.4.1.3 requires that equal tension be maintained between individual ropes in a set. In order to avoid differential wear of sheave grooves and ropes, and to extend rope service life, Gustav Wolf recommends that hoist ropes be equally tensioned at time of installation, after 4-6 weeks, after 6 months and annually thereafter.

Per 8.6.4.1.3 (2013 revision), ropes are considered to be equally tensioned when the smallest tension measured is within 10% of the highest tension measured. Ropes with greater tension/load will press harder into the sheave grooves resulting in increased overall rope wear while ropes with lesser tension/load will slide through the sheave grooves causing increased crown and sheave wear.

Some in the industry use techniques such as "tuning/plucking" or a torque wrench to determine tensioning but the results are rough at best.

Today, highly accurate electronic rope tension measuring devices are available which allow the quick and accurate checking and adjustment of tension. Tension measuring devices are available on pages 19 and 20.

Refer to page 8 for more information on hoist rope tensioning.

DO NOT pay the rope off the top of a coil.

NO

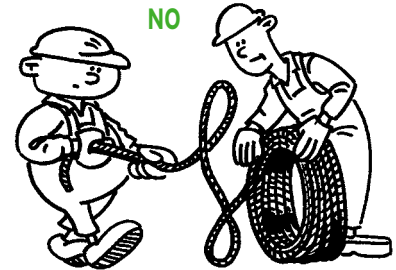

DO NOT pay the rope off the top of a reel.

NO

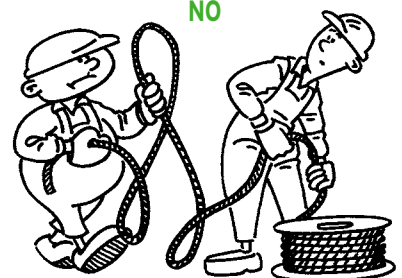

Surface line

Some hoist ropes come with surface lines which help the installers in determining if the ropes have untwisted (this weakens the rope structure and reduces the rope service life).

To use the surface line, make a full up or down run of the elevator after installation and count the number of rotations of the surface line. If the rotations per 100 feet • 30 meters exceed the numbers below, the ropes should be adjusted by rotating the wedge sockets prior to tensioning, installing the retaining clips or tying off the hoist ropes:

Full steel/mixed core (IWRC) with 1:1 roping = 1.5

Full steel/mixed core (IWRC) with 2:1 roping = 3.0

Natural fiber core ropes with 1:1 or 2:1 roping = 3.0

NO

YES

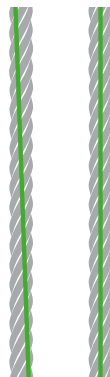

Wire Rope Installation

Overhead 1:1 roping

Overhead 1:1 roping, with its simple path from cab to counterweight, is the most common elevator hoist rope configuration.

Position the car

On a new installation, if the car was not erected at the top landing, raise it there with a hoist. Lock it into position by setting the safety.

Position the counterweight

Place the counterweight in the pit and use proper support to hold it above the floor by this formula:

Rope stretch + runby + buffer height

Refer to page 10 or contact your Gustav Wolf representative to get the approximate amount of stretch for your rope.

Runby is the space between the bottom of the counterweight and the top of the buffer and it can vary due to the specifics of the installation and/or local code. Local code always takes precedence. In this example, a runby of 6 in • 152 mm is assumed.

For example, if your rope under load has a stretch of about 7 in • 178 mm per 100 ft • 30 m of rope and the rope length is 200 ft • 60 m, it will stretch about 14 in • 356 mm. After adding in runby (6 in • 152 mm) and buffer height (e.g. 18 in • 457 mm), the counterweight should be braced with steel supports 14 + 6 + 18 in • 965 mm above the pit floor.

Pull the new rope into position

Rope, either from a reel or a coil, is fed from the top landing to the top of the car. Unreel it as shown on page 6. Do not allow the rope to kink or reverse bend.

The rope is then fed into the machine room and through the first sheave groove.

The rope is then run down to the counterweight. It's sometimes helpful to attach a weight to the rope end using a temporary loop secured with a rope clip.

Use a board as a brake on the reel (like in the YES diagram at the top of page 6) to keep the reel from overspinning.

Use of reeving splices in replacing rope

In re-roping operations, an old rope can be used to pull a new rope into position. Reeving splices (available on page 18 of this catalog) temporarily marry old and new rope ends together. When the old rope is pulled, it guides the new rope over or under the sheaves and to the attachment point at either the car or counterweight.

Reeving splices are designed for specific rope lays and diameters, so make sure to select the proper splice size. They carry a limited working load (refer to page 18 of this catalog for additional information). The weight of the rope load can be calculated from the Net Weight column shown on pages 11 through 15 of this catalog.

Reeving splices are to be used ONCE and then discarded.

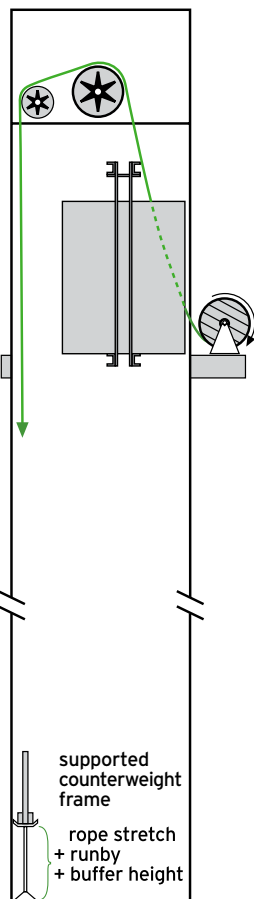

Overhead 2:1 roping

Other roping configurations include the overhead 2:1, which is popular because it permits the use of smaller traction motors.

The same basic principles of hoist rope installation apply. There are several methods of installation, including using a pull rope to raise the hoist rope end to the attachment point at the top of the hoistway.

ALWAYS follow safe working practices including: wearing of personal protective equipment (eye, face, head, foot, hearing, fall-arrest, hand and respiratory), use of lock-out/tag-out procedure, barricading of landing doors, etc. See your company's safety program and the *Elevator Industry Field Employee's Safety Handbook*, edited by the NEII Safety Committee and published by Elevator World.

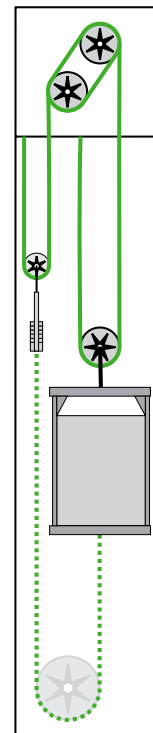

Basement 1:1 roping

Another roping configuration is the basement type 1:1 that features a machine at or below ground level that uses deflecting sheaves to guide the rope into the hoistway.

The same basic principles of hoist rope installation apply. There are several methods of installation, including using a pull rope attached to the hoist rope end to raise the hoist rope from the pit.

Regardless of the manufacturer, all wire ropes have the tendency to untwist leading to weakening of the rope structure and reduced rope service life. Care must always be taken during handling, installation and tensioning to prevent untwisting of the ropes.

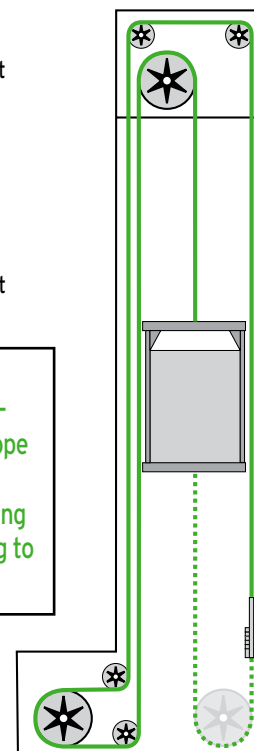

Wedge Socket Installation

Attach the wedge sockets

Wedge sockets (for hoist and compensation ropes) should be attached as shown to both the car and counterweight frames. The threaded rod must be placed with enough exposed thread to permit installation of the washer, nuts and cotter pin.

Prior to cutting the rope, make sure the rope is secure and will not fall down the hoistway. If the rope is set in the sheave groove, that should give enough grip to hold the rope, but you will also need to use a rope clamp attached to the rail to hold the rope.

Mark the cut point of the rope, making sure to leave enough slack for installation (2 to 3 ft • 610 to 915 mm), then seize and cut the rope.

The socket bodies and wedges are color coded and/or marked with their associated rope diameter.

It is common on passenger elevators to install isolation bushing spring assemblies on both the car and counterweight wedge sockets to isolate the car from vibration, provide a more comfortable ride and possibly aid in equalizing the load on the ropes.

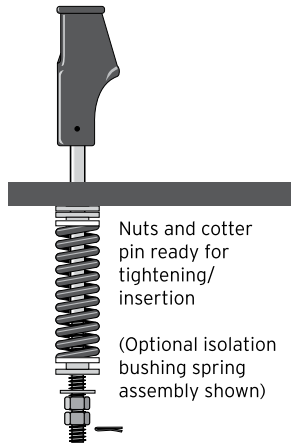

Attach the rope at the counterweight

The counterweight wedge sockets should be attached to the counterweight frame like the wedge sockets at the car frame.

Run the rope down through the counterweight wedge socket body. Repeat the technique shown in steps 1 through 5 in the left hand column of this page.

The rope should be as taut as you can get it using only manual effort.

If the rope is still slack, the rope may need to be re-seated in the wedge socket. Use a hammer and a drift pin to tap the wedge down until the rope loosens. Repeat steps 2 through 4 in the left hand column of this page to tighten the rope.

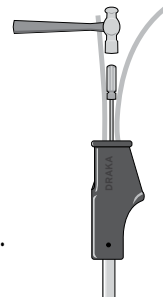

Final "set" under load

After all ropes are installed and the counterweight loaded (on a new installation), release the car and let the weight of the car and counterweight rest on the ropes. The rope and wedge will rise about 1 in • 25 mm to the final "set" under load. All wedges must be visible within the socket bodies after the ropes are loaded.

Attach the rope at the car

1) Run the rope down through the wedge socket body.

2) Thread the rope dead end back up through the top of the wedge socket body. Leave a loop of rope just large enough to insert the wedge.

3) Insert the wedge into the loop.

4) Pull down on the rope with one hand to keep it taut. Use a quick pull on the dead end to seat the wedge.

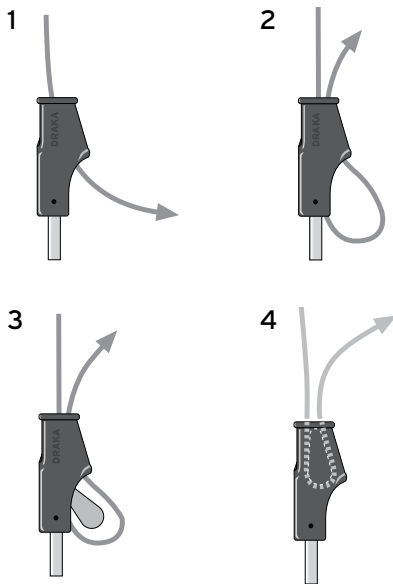

5) The washer and nuts can now be tightened. Use the lower nut to lock the upper nut and washer against the crosshead or the counterweight frame. Insert and bend the cotter pin. (Optional isolation bushing spring assembly shown.)

6) Install two wire rope retaining clips to hold the dead end in place. For clip locations, see diagram 6 at right. Apply no more than 8 ft/lbs • 11 N/m of torque on the bolt and nut.

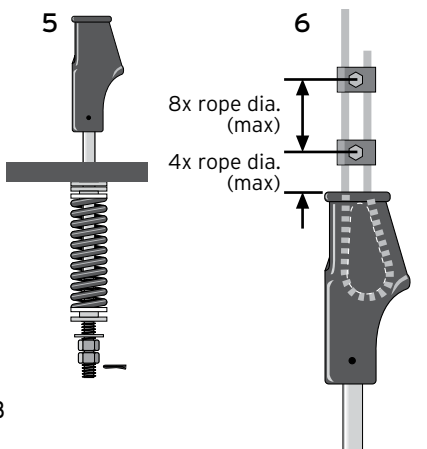

Tension the hoist ropes

If the hoist ropes have surface lines, refer to the "Surface line" section on page 6 of this catalog before proceeding with tensioning.

Use one of the tension measuring devices shown on page 19 or 20 of this catalog to determine which ropes are carrying the most load. Any ropes tighter than the rest can be slackened and equalized using the hammer/drift pin method shown above.

Equalize final rope tension by adjusting the wedge socket rod nuts until all ropes carry tension within a 10% range of each other. Do NOT let the wedge socket rotate during the tensioning process. Rotating the socket body will let the rope untwist and weaken the rope. Hold the wedge socket body to prevent rotation.

Install the retaining clips

Retaining clips bear no load - they are used only to keep the wedge in place should there be a momentary loss of load on the rope. Cut any surplus rope off the rope dead end to leave a tail of about 6 in • 152 mm.

Install two wire rope retaining clips to hold the dead end in place like step 6 to the left. Retaining clips are required at the car and counterweight.

Tie off the hoist ropes

Once equal tension is established, the ropes need to be tied off or secured so that the wedge sockets do not rotate while the elevator is in operation.

Take a length of wire rope (1/2 in • 12.7 mm diameter is customary, but see local codes for approved diameter) and thread it through the wedge socket bodies.

Use wire rope clips to tie together the ends of the binding rope.

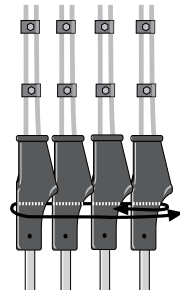

Governor rope wedge sockets

The use of governor rope wedge sockets (two per rope) to attach the governor rope is recommended. Governor rope wedge sockets are available on page 16 of this catalog.



Re-lubrication

Field re-lubrication of wire ropes

Wire ropes have been compared to a machine since they consist of many moving parts (8x19 Seale incorporates 152 individual wires) which are constantly in contact and motion and under pressure. One result of this contact, motion and pressure is the squeezing out of lubricant from the rope core and its transfer to the sheave grooves.

Gustav Wolf elevator ropes are carefully lubricated in the factory for proper operation. However, with usage, time and exposure to the environment it is necessary that the ropes be re-lubricated in the field. In general, elevator system start cycles today are higher than in the past as fewer elevators serve more passengers. Consider too, that modern elevators using smaller sheaves, aggressive sheave groove profiles, fewer ropes, sharper bend radii and increased groove pressures put even greater stress on ropes.

Failure to re-lubricate can result in accelerated sheave groove wear, internal notching, crown wear, core degradation and even rouging. Lack of proper lubrication can reduce rope service life by up to 80%. A regular program of wire rope lubrication is essential to achieve long rope service life and the proper operation of the elevator installation.

Signs of a rope needing lubrication

If there is no established lubrication policy, the easiest way to check the ropes is to stop, safely secure the car and lightly wipe a finger on the ropes. This finger test should show a visible and slippery film of oil. If there is no film, the ropes are in desperate need of lubrication. If the film is visible but does not feel oily, then the ropes need a light amount of lubricant. In the past, mechanics were taught to put a finger in the groove of the sheave to check for the slippery film. This method is no longer acceptable because as ropes dry out, lubrication will be deposited into the undercut (where the rope has no contact). The 'finger in the groove' test will show a tacky black smudge but the ropes could still be bone dry.

Type of lubricant

In North America, Gustav Wolf recommends the use of DrakaLube™ which is available from Draka Elevator Products (or any Gustav Wolf distributor listed on the back cover of this catalog). DrakaLube™ reduces wear, protects against corrosion and displaces moisture in the rope core.

If a lubricant containing solvent is preferred, Gustav Wolf's T 86™ Rope Lubricant is available.

For more details on both DrakaLube and T 86, see page 18 of this catalog.

Lubricant application

Automatic lubricators (available on page 18 of this catalog) are the most time-efficient way to lubricate ropes, but make sure to manually lubricate the ropes that are over the sheave when the car is at its lowest landing, as the oiler does not touch that section of the ropes. Manual methods, such as paintbrushes or rollers, are also acceptable. Whichever method you choose, take care to avoid over-lubrication.

Prior to lubricating, clean all lubrication build-up and dirt from the ropes using an automatic metal-brush cleaner or wire brush. Do NOT use solvents to clean ropes; solvents will break down the rope lubricant and the rope will deteriorate.

Field lubrication policy

Gustav Wolf strongly recommends an annual lubrication application every spring, if the ropes become dry (see "Signs of a rope needing lubrication" in left hand column of this page) or at 250,000 cycles, whichever occurs first.

Ropes should be field lubricated prior to summer and the increased temperature and humidity it brings. Condensation caused by the combination of an air conditioned machine room and a humid hoistway must be kept from entering the rope core.

The practice of re-lubrication based on time interval alone is no longer valid. As already mentioned, ropes on modern elevators are subject to greater stress which requires that cycle counts also be considered when deciding the right time to re-lubricate. Studies show that following the 250,000 cycle guideline will contribute to extended rope service life.

NOTE: Governor ropes should NEVER be re-lubricated.

Amount of lubricant

The rope needs to have sufficient lubricant to eliminate friction between the wires in the strands and between the strands in the rope but not so much as to cause rope slippage in the sheaves. In order to avoid over-lubrication, it is recommended to apply a small amount of lubricant frequently rather than a large amount infrequently.

Table 1 indicates the suggested amount of lubricant for a non-solvent-based lubricant such as DrakaLube. Table 2 shows the recommended amount of lubricant for a solvent-based lubricant such as Gustav Wolf T 86.

Table 1 - DrakaLube

Rope Size inches • mm	Lubricant per 100 ft • 30 m of Rope ounces • milliliters
3/8 • 9.5	1.5 • 45
1/2 • 12.7	2.75 • 80
5/8 • 15.9	4.0 • 120
11/16 • 17.5	5.0 • 150
3/4 • 19.0	6.0 • 175

Table 2 - Gustav Wolf T 86

Rope Size inches • mm	Lubricant per 100 ft • 30 m of Rope ounces • milliliters
3/8 • 9.5	3.0 • 90
1/2 • 12.7	5.5 • 160
5/8 • 15.9	8.0 • 240
11/16 • 17.5	10.0 • 300
3/4 • 19.0	12.0 • 350

After evaporation of the solvent, approximately 50% of the lubricant remains in the rope.

What to do if wire rope gets wet

No amount of lubrication can displace water in ropes that have been in direct contact with water. Exposure of ropes to water results in permanent damage and a very short life expectancy. The only solution for problems associated with wet ropes is to replace them.

Wire Rope Selection Guide

Imperial diameters with part numbers, E-Module and elongation values

Application	Recommended Rope and Rope Part Number	Rope Description	E-Module [†] N/mm ²	Elongation ^{††} per 100' • 30 m of Hoist Rope (Elastic) + (Constructional) = Total inches • mm
Hoist for Low/Mid-rise (up to 200' • 60 m)	F 819 S-FC DT	8x19 Seale	65000 - 70000	(2 - 3) + (2 - 4) = 4 - 7 inches • (51 - 76) + (51 - 102) = 102 - 178 mm
	3/8" = 80-001-A	traction grade		
	1/2" = 80-002-A	natural fiber core		
	5/8" = 80-003-A			
Hoist for Mid/High-rise (> 200' • 60 m)	F 819 S-FC DT EHS	8x19 Seale	65000 - 70000	(2 1/2 - 3) + (2 - 4 1/2) = 4 1/2 - 7 1/2 inches • (63 - 76) + (51 - 114) = 114 - 190 mm
	3/8" = 80-001EHS-A	EHS traction grade		
	1/2" = 80-002EHS-A	natural fiber core		
	5/8" = 80-003EHS-A			
	PAWO F3	8x19 Seale	75000 - 80000	(1 1/2 - 2) + (1 1/2 - 2) = 3 - 4 inches • (38 - 51) + (38 - 51) = 76 - 102 mm
	3/8" = 80-016-A	EHS traction grade*		
	1/2" = 80-020-A	steel-reinforced natural fiber core		
	5/8" = 80-024-A	(lower-stretch alternative to F 819 S-FC DT EHS above)		
11/16" = 80-047-A				
Hoist for High-rise (> 300' • 90 m)	PAWO F10	9x17 or 9x21 Filler Wire	80000 - 85000	(1 1/2 - 2) + (1/2 - 1) = 2 - 3 inches • (38 - 51) + (13 - 25) = 51 - 76 mm
	3/8" = 80-104	EHS traction grade*		
	1/2" = 80-108	full steel core		
	5/8" = 80-113			
11/16" = 80-115				
Hoist for Installations with Reverse Bends (e.g. Basement Machines)	CompactTrac™	8x19 Seale/compacted strands	65000 - 70000	(2 - 3) + (2 - 4) = 4 - 7 inches • (51 - 76) + (51 - 102) = 102 - 178 mm
	3/8" = 80-001CSLL-A	traction grade		
	1/2" = 80-002CSLL-A	natural fiber core		
5/8" = 80-003CSLL-A				
Governor (select Seale in Traction or Warrington in Traction or Iron)	F 819 S-FC DT	8x19 Seale	-	-
	1/4" = 80-000-A	traction grade		
	3/8" = 80-001-A	natural fiber core		
	1/2" = 80-002-A			
	5/8" = 80-003-A			
	F 819 W-FC DT	8x19 Warrington	-	-
	3/8" = 80-001W	traction grade		
		natural fiber core		
	F 819 W-FC DT Iron	8x19 Warrington	-	-
3/8" = 80-010IRONW	iron grade			
7/16" = 80-007IRON-K (Seale)	natural fiber core			
Compensation/Governor (select Traction or Iron)	F 819 F-FC DT	8x25 Filler Wire	-	-
	1/2" = 80-002FW	traction grade		
	5/8" = 80-003FW	natural fiber core		
	3/4" = 80-013FW			
	F 819 F-FC DT Iron	8x25 Filler Wire	-	-
	1/2" = 80-011IRONFW	iron grade		
5/8" = 80-012IRONFW	natural fiber core			
3/4" = 80-013IRONFW-K				

Other imperial diameters are available. Refer to pages 11 - 12 of this catalog or contact your Gustav Wolf representative for additional information.

1) The goal of the suggested hoist rope guidelines is to achieve maximum rope service life and minimum rope elongation. The guidelines for hoist rope are based on Rise/Travel and apply to standard 1:1 overhead machine installations only unless otherwise indicated. Other machine arrangements should be discussed with your Gustav Wolf representative prior to ordering.

2) It is strongly recommended that the sheaves of existing elevators be carefully checked and re-grooved or replaced as necessary prior to rope replacement. The diameter of the new ropes is greater than that of the old ropes and failure to bring the sheave grooves into the machine manufacturer's specified tolerances can lead to vibration, metal shavings and other problems.

3) To insure maximum rope and sheave life a program of regular re-lubrication should be adopted. Refer to page 9 of this catalog for information on field re-lubrication. DrakaLube™ and Gustav Wolf T 86 are available (see page 18).

4) Rope and sheave life will be maximized if hoist rope tension is equalized (within a 10% range) at the time of rope installation and at regular intervals thereafter (see page 6 for more information). The use of the portable RTS Rope Tensioning System (available on page 19 of this catalog) is recommended.

Range of acceptable traction sheave hardness based on rope grade/tensile strength:

Wire Rope Type (see table above and other ropes in this catalog)	Minimum Tensile Strength of Outer Wires (N/mm ² • psi)	Hardness of Traction Sheave (Brinell)
F 819 W-FC DT Iron & F 819 F-FC DT Iron	680 • 100,000 (iron grade)	For governor/ compensation only
F 819 S-FC DT, CompactTrac™, F 819 W-FC DT & F 819 F-FC DT	1180 • 170,000 (traction grade)	180 - 200
Metric F 819 S-FC DT	1370 • 198,800	200 - 230
PAWO F3, F7, F7S & F10	1570 • 227,800	220 - 240
F 819 S-FC DT EHS	1670 • 245,000 (EHS traction grade)	230 - 250

[†] Modulus of elasticity is calculated per VDI 2358-1984.

^{††} Elongation is calculated at 10% of Minimum Breaking Force (MBF).

*Actual minimum tensile strength of outer wires is 1570 N/mm² (227,800 psi).

Wire Rope

Imperial diameters to meet ASME A17.1/CSA B44 and A17.6 for standard applications

Hoist and governor - 8 x 19 Seale with natural fiber core

Part Number	Application	Diameter inches	Grade	Right Lay	Min. Breaking Force lbf • N	Net Weight lbs/ft • kg/m
80-000-A	Hoist / Gov.	1/4	Traction	Regular	3600 • 16025	0.09 • 0.14
80-001-A	Hoist / Gov.	3/8	Traction	Regular	8200 • 36475	0.21 • 0.31
80-001EHS-A	Hoist	3/8	EHST	Regular	9900 • 44050	0.21 • 0.31
80-001EHSLL-A	Hoist	3/8	EHST	Lang	9900 • 44050	0.21 • 0.31
80-007IRON-K	Governor	7/16	Iron	Regular	5600 • 24900	0.28 • 0.42
80-002-A	Hoist / Gov.	1/2	Traction	Regular	14500 • 64500	0.36 • 0.54
80-002LL-A	Hoist	1/2	Traction	Lang	14500 • 64500	0.36 • 0.54
80-002EHS-A	Hoist	1/2	EHST	Regular	17500 • 77850	0.36 • 0.54
80-002EHSLL-A	Hoist	1/2	EHST	Lang	17500 • 77850	0.36 • 0.54
80-038-A	Hoist	9/16	Traction	Regular	18500 • 82300	0.46 • 0.68
80-038EHS-A	Hoist	9/16	EHST	Regular	22100 • 98300	0.46 • 0.68
80-003-A	Hoist / Gov.	5/8	Traction	Regular	23000 • 102300	0.58 • 0.86
80-003LL-A	Hoist	5/8	Traction	Lang	23000 • 102300	0.58 • 0.86
80-003EHS-A	Hoist	5/8	EHST	Regular	27200 • 121000	0.58 • 0.86
80-003EHSLL-A	Hoist	5/8	EHST	Lang	27200 • 121000	0.58 • 0.86
80-039-A	Hoist	11/16	Traction	Regular	27000 • 120100	0.69 • 1.03
80-039LL-A	Hoist	11/16	Traction	Lang	27000 • 120100	0.69 • 1.03
80-039EHS-A	Hoist	11/16	EHST	Regular	32800 • 145900	0.69 • 1.03
80-039EHSLL-A	Hoist	11/16	EHST	Lang	32800 • 145900	0.69 • 1.03
80-013-A	Hoist	3/4	Traction	Regular	32000 • 142350	0.82 • 1.22
80-013EHS-A	Hoist	3/4	EHST	Regular	38900 • 173025	0.82 • 1.22
80-013EHSLL-A	Hoist	3/4	EHST	Lang	38900 • 173025	0.82 • 1.22
80-040-A	Hoist	13/16	Traction	Regular	37000 • 164575	0.96 • 1.43
80-014-A	Hoist	7/8	Traction	Regular	42000 • 186825	1.11 • 1.65
80-042-A	Hoist	1	Traction	Regular	54000 • 240200	1.45 • 2.16

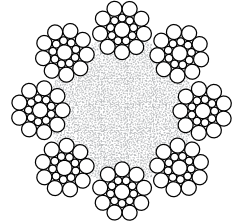

Most popular rope design in North America. Eight-strand/Seale construction with its larger outer wires better resists abrasion and wear. Dual-tensile design provides high-breaking strength without damage to sheaves with lower Brinell hardness. Available in Traction or Extra High Strength Traction (EHST) grade and Right Regular or Right Lang lay.

Governor - 8 x 19 Warrington with natural fiber core

Part Number	Application	Diameter inches	Grade	Right Lay	Min. Breaking Force lbf • N	Net Weight lbs/ft • kg/m
80-001W	Governor	3/8	Traction	Regular	8200 • 36475	0.20 • 0.30
80-010IRONW	Governor	3/8	Iron	Regular	4200 • 18675	0.20 • 0.30

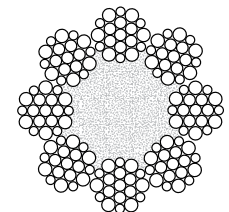

Eight-strand/Warrington construction is more flexible and makes this rope well-suited for governor applications. Available in Traction or Iron grade.

Compensation and governor - 8 x 25 Filler Wire with natural fiber core

Part Number	Application	Diameter inches	Grade	Right Lay	Min. Breaking Force lbf • N	Net Weight lbs/ft • kg/m
80-002FW	Comp./Gov.	1/2	Traction	Regular	14500 • 64500	0.36 • 0.54
80-011IRONFW	Comp./Gov.	1/2	Iron	Regular	7200 • 32025	0.36 • 0.54
80-003FW	Comp./Gov.	5/8	Traction	Regular	23000 • 102300	0.62 • 0.92
80-012IRONFW	Comp./Gov.	5/8	Iron	Regular	11200 • 49825	0.62 • 0.92
80-013FW	Compensation	3/4	Traction	Regular	32000 • 142350	0.82 • 1.22
80-013IRONFW-K	Compensation	3/4	Iron	Regular	16000 • 71175	0.82 • 1.22

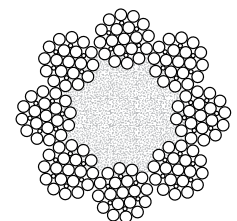

Eight-strand/Filler Wire construction with its higher wire count provides greater flexibility and makes this rope a good match for compensation applications. Available in Traction or Iron grade.

All listed Gustav Wolf wire rope is **preformed, right lay** with a **bright** (uncoated) finish. All popular items are in stock for immediate delivery. Less popular items and other diameters, strandings, constructions, grades, coatings, etc. are available by special order.

Wire Rope

Imperial diameters to meet ASME A17.1/CSA B44 and A17.6 for special applications

Hoist and compensation PAWO F3 - 8 x 19 Seale with steel-reinforced natural fiber core

Part Number	Application	Diameter inches	Tensile Strength N/mm ²	Right Lay	Min. Breaking Force lbf • N	Net Weight lbs/ft • kg/m
80-016-A	Hoist	3/8	1570	Regular	12225 • 54400	0.24 • 0.35
80-020-A	Hoist	1/2	1570	Regular	22100 • 98300	0.42 • 0.62
80-024-A	Hoist/Comp.	5/8	1570	Regular	34800 • 154800	0.66 • 0.98
80-047-A	Hoist/Comp.	1 1/16	1570	Regular	42050 • 187000	0.81 • 1.20
80-048-A	Hoist/Comp.	3/4	1570	Regular	48925 • 217600	0.93 • 1.38

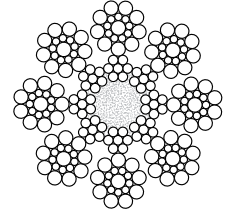

Steel-reinforced natural fiber core provides reduced stretch and cross-section deformation with higher breaking strength. Eight-strand/Seale construction with its larger outer wires increases wear resistance. Recommended for use on mid/high-rise elevators wherever Extra High Strength Traction (EHST) grade wire rope is specified to extend rope service life and reduce or eliminate the labor cost of repeated rope shortening. PAWO F3 comes with a green surface line.

Hoist and compensation PAWO F10 - 9 x 17 or 9 x 21 Filler Wire with Independent Wire Rope Core

Part Number	Construction	Application	Diameter inches	Tensile Strength N/mm ²	Right Lay	Min. Breaking Force lbf • N	Net Weight lbs/ft • kg/m
80-104	9 x 17 Filler Wire	Hoist	3/8	1570	Regular	13600 • 60500	0.26 • 0.38
80-108	9 x 21 Filler Wire	Hoist	1/2	1570	Regular	24625 • 109500	0.46 • 0.68
80-113	9 x 21 Filler Wire	Hoist/Comp.	5/8	1570	Regular	39125 • 174000	0.73 • 1.08
80-115	9 x 21 Filler Wire	Hoist/Comp.	1 1/16	1570	Regular	46750 • 208000	0.87 • 1.30
80-117	9 x 21 Filler Wire	Hoist/Comp.	3/4	1570	Regular	55050 • 244900	1.02 • 1.51

Designed specifically for demanding high-rise/high-speed applications. Full steel core (IWRC) and nine-strand/Filler Wire construction work together to achieve minimal stretch, a round cross-section, excellent flexibility, increased resistance to rope fatigue due to bending and maximized breaking strength. Recommended for use on high-rise/high-speed elevators wherever Extra High Strength Traction (EHST) grade wire rope is specified to achieve the ultimate in wire rope performance. PAWO F10 comes with a white surface line.

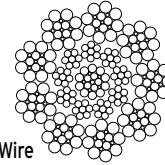

80-104
9 x 17 Filler Wire
with IWRC

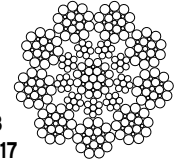

80-108
to 80-117
9 x 21 Filler Wire with IWRC

Hoist CompactTrac™ compacted strand - 8 x 19 Seale with natural fiber core

Part Number	Application	Diameter inches	Tensile Strength N/mm ²	Right Lay	Min. Breaking Force lbf • N	Net Weight lbs/ft • kg/m
80-001CSLL-A	Hoist	3/8	Traction	Lang	9400 • 41800	0.22 • 0.32
80-002CSLL-A	Hoist	1/2	Traction	Lang	17050 • 75800	0.39 • 0.58
80-003CSLL-A	Hoist	5/8	Traction	Lang	26925 • 119800	0.62 • 0.92

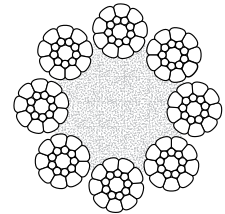

Compacted strand design of this eight-strand/Seale rope increases bending resistance. The larger contact area between ropes and sheaves reduces surface pressure and helps extend short rope service life associated with rope fatigue due to reverse bends e.g. basement machines. This is a Right Lang lay rope in Traction grade.

Hoist and governor galvanized - 8 x 19 Seale with fiber core

Part Number	Application	Diameter inches	Tensile Strength N/mm ²	Right Lay	Min. Breaking Force lbf • N	Net Weight lbs/ft • kg/m
80-001G-K	Hoist / Gov.	3/8	Traction	Regular	8200 • 36475	0.21 • 0.31
80-002G-A	Hoist / Gov.	1/2	Traction	Regular	14500 • 64500	0.36 • 0.54
80-003G-A	Hoist / Gov.	5/8	Traction	Regular	23000 • 102300	0.58 • 0.86

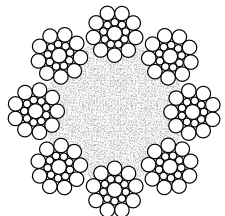

Galvanized coating on wires helps protect ropes from weather and corrosion associated with outdoor and mine elevators. This is an eight-strand/Seale construction rope in Traction grade.

Hoist, compensation and governor - 6 x 25 Filler Wire with natural fiber core

Part Number	Application	Diameter inches	Tensile Strength N/mm ²	Right Lay	Min. Breaking Force lbf • N	Net Weight lbs/ft • kg/m
80-075FW	Hoist	1/2	Traction	Regular	14500 • 64500	0.40 • 0.60
80-075EHSFW	Hoist	1/2	EHST	Regular	20400 • 90750	0.40 • 0.60
80-076FW-K	Hoist	5/8	Traction	Regular	23000 • 102300	0.63 • 0.94
80-076IRONFW	Comp./Gov.	5/8	Iron	Regular	12800 • 56925	0.63 • 0.94

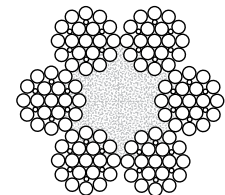

Six-strand/Filler Wire rope is less flexible than eight-strand/Filler Wire rope but it is used in a limited number of older hoist, compensation and governor applications. Available in Traction, Extra High Strength Traction (EHST) or Iron grade.

All listed Gustav Wolf wire rope is **preformed, right lay** with a **bright** (uncoated) finish (except for 80-001G-K, 80-002G-A and 80-003G-A above which are galvanized). All popular items are in stock for immediate delivery.

Less popular items and other diameters, strandings, constructions, grades, coatings, etc. are available by special order.

Wire Rope

Metric diameters to meet DIN EN 12385, ISO 4344, ASME A17.1/CSA B44 and A17.6

Metric hoist and compensation F 819 S-FC DT - 8 x 19 Seale with natural fiber core

Part Number	Application	Diameter mm	Tensile Strength N/mm ²	Right Lay	Min. Breaking Force lbf • N	Net Weight lbs/ft • kg/m
80-005-A	Hoist	8.0	1370/1770	Regular	6850 • 30500	0.15 • 0.22
80-090-A	Hoist	9.0	1370/1770	Regular	8625 • 38400	0.19 • 0.28
80-006-A	Hoist	10.0	1370/1770	Regular	10825 • 48200	0.24 • 0.35
80-007-S	Hoist	11.0	1370/1770	Regular	13125 • 58400	0.29 • 0.43
80-008-A	Hoist	12.0	1370/1770	Regular	15550 • 69200	0.34 • 0.50
80-009-A	Hoist	13.0	1370/1770	Regular	18150 • 80700	0.40 • 0.59
80-096-A	Hoist	14.0	1370/1770	Regular	20900 • 93000	0.46 • 0.68
80-097-A	Hoist/Comp.	15.0	1370/1770	Regular	24275 • 108000	0.52 • 0.78
80-098-A	Hoist/Comp.	16.0	1370/1770	Regular	27200 • 121000	0.60 • 0.89
80-099-A	Hoist/Comp.	18.0	1370/1770	Regular	34625 • 154000	0.75 • 1.11
80-091-A	Hoist/Comp.	19.0	1370/1770	Regular	38450 • 171000	0.85 • 1.26

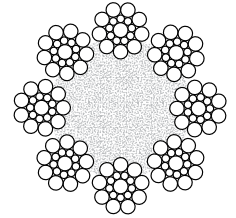

A popular metric rope design used in many standard hoist and compensation applications. Eight-strand/Seale construction with its larger outer wires better resists abrasion and wear. Dual-tensile design provides high-breaking strength without damage to sheaves with lower Brinell hardness.

Metric governor - refer to specifications below

Part Number	Construction	Application	Diameter mm	Tensile Strength N/mm ²	Right Lay	Min. Breaking Force lbf • N	Net Weight lbs/ft • kg/m
80-074	6 x 19 Seale	Governor	6.0	1770	Regular	4725 • 21000	0.09 • 0.13
80-080-S	6 x 19 Seale	Governor	6.0	1770	Regular	4725 • 21000	0.09 • 0.13
80-086	6 x 19 Seale - PAWO F3	Governor	6.0	1960	Regular	6175 • 27500	0.10 • 0.15
80-084	6 x 19 Warrington	Governor	6.5	1770	Regular	5800 • 25800	0.11 • 0.16
80-043-A	6 x 19 Seale - PAWO F3	Governor	6.5	1570	Regular	5825 • 25900	0.11 • 0.16
80-094	8 x 19 Warrington - PAWO 819W	Governor	6.5	1770	Regular	6675 • 29700	0.12 • 0.17
80-045-A	8 x 19 Seale - PAWO F3	Governor	8.0	1570	Regular	8550 • 38000	0.16 • 0.24
80-102	9 x 17 Filler Wire - PAWO F10	Governor	8.0	1570	Regular	9700 • 43200	0.18 • 0.27
80-077	8 x 19 Seale	Governor	9.5	1770	Regular	10525 • 46800	0.21 • 0.31
80-016-A	8 x 19 Seale - PAWO F3	Governor	9.5	1570	Regular	12225 • 54400	0.24 • 0.35
80-104	9 x 17 Filler Wire - PAWO F10	Governor	9.5	1570	Regular	13600 • 60500	0.26 • 0.38
80-105	9 x 17 Filler Wire - PAWO F10	Governor	10.0	1570	Regular	15100 • 67200	0.28 • 0.42

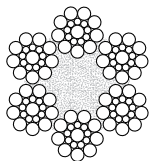

80-074 and 80-080-S are 6 x 19 Seale with synthetic fiber core. 80-080-S is galvanized.

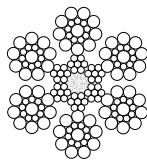

80-086 and 80-043-A are 6 x 19 PAWO F3 Seale with steel-reinforced natural fiber core.

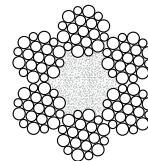

80-084 is 6 x 19 Warrington with natural fiber core.

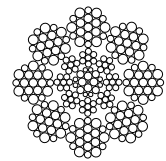

80-094 is 8 x 19 PAWO 819W Warrington with full steel core (IWRC).

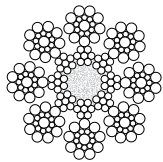

80-045-A and 80-016-A are 8 x 19 PAWO F3 Seale with steel-reinforced natural fiber core.

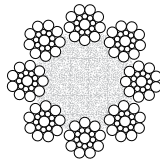

80-077 is 8 x 19 Seale with synthetic fiber core, galvanized.

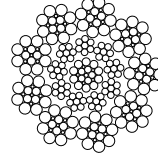

80-102, 80-104 and 80-105 are 9 x 17 PAWO F10 Filler Wire with full steel core (IWRC).

All listed Gustav Wolf wire rope is **preformed, right lay** with a **bright** (uncoated) finish (except for 80-080-S and 80-077 above which are galvanized).

All popular items are in stock for immediate delivery.

Less popular items and other diameters, strandings, constructions, grades, coatings, etc. are available by special order.

Wire Rope

Metric diameters to meet DIN EN 12385, ISO 4344, ASME A17.1/CSA B44 and A17.6

Metric hoist and compensation PAWO F3 - 8 x 19 Seale with steel-reinforced natural fiber core

Part Number	Application	Diameter mm	Tensile Strength N/mm ²	Right Lay	Min. Breaking Force lbf • N	Net Weight lbs/ft • kg/m
80-045-A	Hoist	8.0	1570	Regular	8550 • 38000	0.16 • 0.24
80-015-A	Hoist	9.0	1570	Regular	10850 • 48300	0.21 • 0.31
80-017-A	Hoist	10.0	1570	Regular	13600 • 60500	0.26 • 0.39
80-018-A	Hoist	11.0	1570	Regular	16500 • 73400	0.32 • 0.47
80-019-A	Hoist	12.0	1570	Regular	19525 • 86800	0.37 • 0.55
80-021-A	Hoist	13.0	1570	Regular	23175 • 103100	0.44 • 0.65
80-022-A	Hoist	14.0	1570	Regular	26825 • 119300	0.51 • 0.75
80-023-A	Hoist/Comp.	15.0	1570	Regular	30925 • 137600	0.59 • 0.87
80-024-A	Hoist/Comp.	16.0	1570	Regular	34800 • 154800	0.66 • 0.98
80-026-A	Hoist/Comp.	18.0	1570	Regular	43525 • 193600	0.83 • 1.23
80-048-A	Hoist/Comp.	19.0	1570	Regular	48925 • 217600	0.93 • 1.38

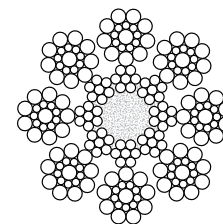

Steel-reinforced natural fiber core provides reduced stretch and cross-section deformation with higher breaking strength. Eight-strand/Seale construction with its larger outer wires increases wear resistance. PAWO F3 comes with a green surface line.

Metric hoist PAWO F7 - 8 x 19 Warrington with steel-reinforced natural fiber core

Part Number	Application	Diameter mm	Tensile Strength N/mm ²	Right Lay	Min. Breaking Force lbf • N	Net Weight lbs/ft • kg/m
80-056-A	Hoist	8.0	1570	Regular	9125 • 40600	0.18 • 0.26
80-027-A	Hoist	9.0	1570	Regular	11650 • 51800	0.22 • 0.33
80-029-A	Hoist	10.0	1570	Regular	14250 • 63400	0.27 • 0.40
80-030-A	Hoist	11.0	1570	Regular	17275 • 76800	0.33 • 0.49
80-031-A	Hoist	12.0	1570	Regular	20400 • 90700	0.38 • 0.57
80-033-A	Hoist	13.0	1570	Regular	23600 • 105000	0.45 • 0.67
80-034-A	Hoist	14.0	1570	Regular	27950 • 124300	0.53 • 0.78
80-035-A	Hoist	15.0	1570	Regular	31450 • 139900	0.60 • 0.89
80-036-A	Hoist	16.0	1570	Regular	36050 • 160400	0.69 • 1.02
80-059-A	Hoist	19.0	1570	Regular	50725 • 225600	0.96 • 1.42

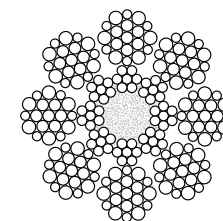

Steel-reinforced natural fiber core provides reduced stretch and cross-section deformation with higher breaking strength. More flexible eight-strand/Warrington construction resists rope fatigue due to bending in installations with numerous rope bends. PAWO F7 comes with a green surface line.

Metric hoist PAWO F7S - 8 x 19 Warrington with Independent Wire Rope Core

Part Number	Application	Diameter mm	Tensile Strength N/mm ²	Right Lay	Min. Breaking Force lbf • N	Net Weight lbs/ft • kg/m
80-056SC	Hoist	8.0	1570	Regular	10025 • 44600	0.19 • 0.28
80-027SC	Hoist	9.0	1570	Regular	12600 • 56000	0.24 • 0.36
80-029SC-S	Hoist	10.0	1570	Regular	15625 • 69500	0.30 • 0.44
80-030SC	Hoist	11.0	1570	Regular	18675 • 83100	0.35 • 0.52
80-031SC	Hoist	12.0	1570	Regular	22225 • 98900	0.42 • 0.62
80-033SC	Hoist	13.0	1570	Regular	26075 • 116000	0.49 • 0.73
80-034SC	Hoist	14.0	1570	Regular	30300 • 134800	0.58 • 0.86
80-035SC	Hoist	15.0	1570	Regular	34350 • 152800	0.65 • 0.96
80-036SC	Hoist	16.0	1570	Regular	39600 • 176100	0.74 • 1.10
80-004SC	Hoist	18.0	1570	Regular	49150 • 218600	0.93 • 1.38
80-059SC	Hoist	19.0	1570	Regular	55125 • 245200	1.04 • 1.54

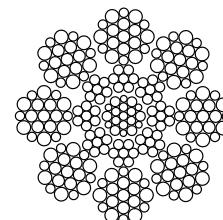

Full steel core (IWRC) reduces stretch and cross-section deformation to a minimum while maximizing breaking strength. More flexible eight-strand/Warrington construction resists rope fatigue due to bending in installations with numerous rope bends and smaller sheaves. PAWO F7S comes with a green surface line.

All listed Gustav Wolf wire rope is **preformed, right lay** with a **bright** (uncoated) finish. All popular items are in stock for immediate delivery. Less popular items and other diameters, strandings, constructions, grades, coatings, etc. are available by special order.

Wire Rope

Metric diameters to meet DIN EN 12385, ISO 4344, ASME A17.1/CSA B44 and A17.6

Metric hoist PAWO F10 - 9 x 17 Filler Wire with Independent Wire Rope Core

Part Number	Application	Diameter mm	Tensile Strength N/mm ²	Right Lay	Min. Breaking Force lbf • N	Net Weight lbs/ft • kg/m
80-102	Hoist	8.0	1570	Regular	9700 • 43200	0.18 • 0.27
80-103	Hoist	9.0	1570	Regular	12325 • 54800	0.23 • 0.34
80-105	Hoist	10.0	1570	Regular	15100 • 67200	0.28 • 0.42
80-106	Hoist	11.0	1570	Regular	18025 • 80200	0.34 • 0.51
80-107	Hoist	12.0	1570	Regular	21500 • 95600	0.40 • 0.60

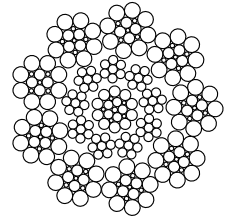

Designed specifically for demanding high-rise/high-speed applications using rope diameters of 8.0 to 12.0 mm. Full steel core (IWRC) and nine-strand/Filler Wire construction work together to achieve minimal stretch, a round cross-section, excellent flexibility, increased resistance to rope fatigue due to bending and maximized breaking strength. PAWO F10 comes with a white surface line.

Metric hoist and compensation PAWO F10 - 9 x 21 Filler Wire with Independent Wire Rope Core

Part Number	Application	Diameter mm	Tensile Strength N/mm ²	Right Lay	Min. Breaking Force lbf • N	Net Weight lbs/ft • kg/m
80-109	Hoist	13.0	1570	Regular	25500 • 113400	0.48 • 0.71
80-110	Hoist	14.0	1570	Regular	30500 • 135700	0.57 • 0.85
80-112	Hoist/Comp.	15.0	1570	Regular	34350 • 152800	0.64 • 0.95
80-113	Hoist/Comp.	16.0	1570	Regular	39125 • 174000	0.73 • 1.08
80-116	Hoist/Comp.	18.0	1570	Regular	49400 • 219700	0.92 • 1.37
80-117	Hoist/Comp.	19.0	1570	Regular	55050 • 244900	1.02 • 1.51

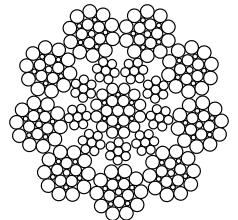

Designed specifically for demanding high-rise/high-speed applications using rope diameters of 13.0 mm and larger. Full steel core (IWRC) and nine-strand/Filler Wire construction work together to achieve minimal stretch, a round cross-section, excellent flexibility, increased resistance to rope fatigue due to bending and maximized breaking strength. PAWO F10 comes with a white surface line.

Wire Rope with Electrical Conductors

Metric diameters to meet DIN EN 12385, DIN EN 1808, ASME A17.1/CSA B44 and A17.6

Metric hoist PAWO F4e - 8 x 19 Seale with synthetic fiber core and two 0.96 mm² (>18 AWG) conductors

Part Number	Application	Diameter mm	Tensile Strength N/mm ²	Right Lay	Min. Breaking Force lbf • N	Net Weight lbs/ft • kg/m
80-081	Hoist	8.0	1770	Regular	7475 • 33200	0.17 • 0.25

Galvanized coating on wires and two (2) electrical conductors make this eight-strand/Seale rope suitable for use on outdoor maintenance platforms and similar applications. Diameters in addition to 8.0 mm are available.

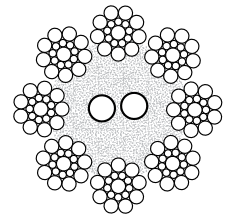

Metric hoist PAWO F5e - 6 x 19 Seale with synthetic fiber core and one 0.96 mm² (>18 AWG) conductor

Part Number	Application	Diameter mm	Tensile Strength N/mm ²	Right Lay	Min. Breaking Force lbf • N	Net Weight lbs/ft • kg/m
80-067	Hoist	8.0	1770	Regular	8600 • 38200	0.16 • 0.23

Galvanized coating on wires and one (1) electrical conductor make this six-strand/Seale rope suitable for use on outdoor maintenance platforms and similar applications. Diameters in addition to 8.0 mm are available.

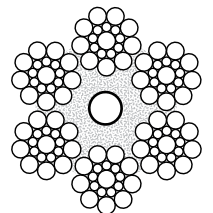

All listed Gustav Wolf wire rope is **preformed, right lay** with a **bright** (uncoated) finish (except for 80-081 and 80-067 above which are galvanized).

All popular items are in stock for immediate delivery.

Less popular items and other diameters, strandings, constructions, grades, coatings, etc. are available by special order.

Wire Rope Accessories

To meet ASME A17.1/CSA B44 • New York MEA approval #410-O3-M

Wire rope wedge sockets

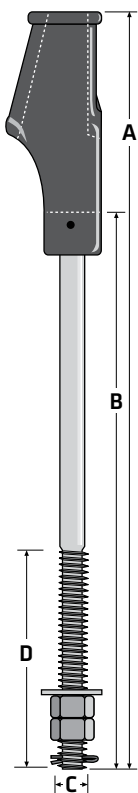

Part Number	Rope Size inches • mm	Dim (A) nom inches • mm (+/- 3/16 • 5)	Dim (B) nom inches • mm (+/- 3/16 • 5)	Dim (C) Metric Thread	Usable Thread minimum inches • mm	Dim (D) nom inches • mm (+/- 3/8 • 10)
WSY-516-12	5/16 • 8	17-1/2 • 445	12-19/32 • 320	M12	7-7/8 • 200	8-27/32 • 225
WSY-516-18	5/16 • 8	23-3/4 • 603	18-7/8 • 480	M12	9-13/16 • 250	10-13/16 • 275
WSY-516-24	5/16 • 8	30-1/8 • 765	24-3/16 • 640	M12	15-3/4 • 400	16-23/32 • 425
WSY-38-12	3/8 • 9 to 10	17-1/2 • 445	12-19/32 • 320	M12	7-7/8 • 200	8-27/32 • 225
WSY-38-18	3/8 • 9 to 10	23-3/4 • 603	18-7/8 • 480	M12	9-13/16 • 250	10-13/16 • 275
WSY-38-24	3/8 • 9 to 10	30-1/8 • 765	24-3/16 • 640	M12	15-3/4 • 400	16-23/32 • 425
WSY-12-12-A	7/16 to 1/2 • 11 to 13	18 • 457	12-19/32 • 320	M20	7-7/8 • 200	8-27/32 • 225
WSY-12-18-A	7/16 to 1/2 • 11 to 13	24-3/8 • 619	18-7/8 • 480	M20	9-13/16 • 250	10-13/16 • 275
WSY-12-24-A	7/16 to 1/2 • 11 to 13	30-5/8 • 778	24-3/16 • 640	M20	15-3/4 • 400	16-23/32 • 425
WSY-12-30-A	7/16 to 1/2 • 11 to 13	36-7/8 • 937	30-1/2 • 800	M20	15-3/4 • 400	16-23/32 • 425
WSY-12-36-A	7/16 to 1/2 • 11 to 13	43-1/4 • 1099	36-13/16 • 960	M20	15-3/4 • 400	16-23/32 • 425
WSY-58-12	9/16 to 5/8 • 14 to 16	19-3/4 • 502	12-19/32 • 320	M20	7-7/8 • 200	8-27/32 • 225
WSY-58-18	9/16 to 5/8 • 14 to 16	26-1/8 • 664	18-7/8 • 480	M20	9-13/16 • 250	10-13/16 • 275
WSY-58-24	9/16 to 5/8 • 14 to 16	32-3/8 • 822	24-3/16 • 640	M20	15-3/4 • 400	16-23/32 • 425
WSY-58-30	9/16 to 5/8 • 14 to 16	38-3/4 • 984	30-1/2 • 800	M20	15-3/4 • 400	16-23/32 • 425
WSY-58-36	9/16 to 5/8 • 14 to 16	45 • 1143	36-13/16 • 960	M20	15-3/4 • 400	16-23/32 • 425
WSY-34-12	11/16 to 3/4 • 17.5 to 19	21-1/4 • 540	12-19/32 • 320	M24	7-7/8 • 200	8-27/32 • 225
WSY-34-18	11/16 to 3/4 • 17.5 to 19	27-1/2 • 699	18-7/8 • 480	M24	9-13/16 • 250	10-13/16 • 275
WSY-34-24	11/16 to 3/4 • 17.5 to 19	33-3/4 • 857	24-3/16 • 640	M24	15-3/4 • 400	16-23/32 • 425
WSY-34-30	11/16 to 3/4 • 17.5 to 19	39-3/4 • 1010	30-1/2 • 800	M24	15-3/4 • 400	16-23/32 • 425
WSY-34-36	11/16 to 3/4 • 17.5 to 19	46-1/4 • 1175	36-13/16 • 960	M24	15-3/4 • 400	16-23/32 • 425

Each wedge socket consists of the socket, rod, 1 wedge, 2 nuts, 1 washer, 1 cotter pin and 2 retaining clips.

Wedge sockets are tested with full steel core (IWRC) rope and exceed ASME A17.1 Rule 2.20.9 and all other applicable safety codes.

Component Specifications:

Socket: Cast steel ASTM-A27, Grade 60-30 stress relieved

Rod: Rolled or forged steel ASTM 668

Wedge: Cast steel ASTM-A27, Grade 60-30

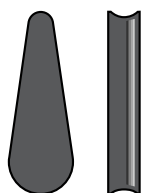

Wedge socket wedges

Part Number	Size / Color inches • mm / color
WS-WEDGE-516	5/16 • 8 / green
WS-WEDGE-38	3/8 • 9 to 10 / blue
WS-WEDGE-12-B	7/16 to 1/2 • 11 to 13 / black
WS-WEDGE-58	9/16 to 5/8 • 14 to 16 / red
WS-WEDGE-34	11/16 to 3/4 • 17.5 to 19 / yellow

Wedge: Cast steel ASTM-A27, Grade 60-30

These wedges are for use ONLY with the wedge sockets listed above.

Wedge socket components

Part Number	Size and Description inches • mm
WS-NUT-38	5/16 to 3/8 • 8 to 10 nut
WS-NUT-12	7/16 to 1/2 • 11 to 13 nut
WS-NUT-58	9/16 to 5/8 • 14 to 16 nut
WS-NUT-34	11/16 to 3/4 • 17.5 to 19 nut
WS-CPIN-38	5/16 to 3/8 • 8 to 10 cotter pin
WS-CPIN-12	7/16 to 1/2 • 11 to 13 cotter pin
WS-CPIN-58	9/16 to 5/8 • 14 to 16 cotter pin
WS-CPIN-34	11/16 to 3/4 • 17.5 to 19 cotter pin
WS-WSHR-38	5/16 to 3/8 • 8 to 10 washer
WS-WSHR-12	7/16 to 1/2 • 11 to 13 washer
WS-WSHR-58	9/16 to 5/8 • 14 to 16 washer
WS-WSHR-34	11/16 to 3/4 • 17.5 to 19 washer

Wedge socket retaining clips

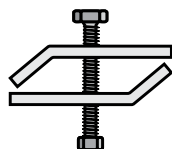

Part Number	Size and Description inches • mm
WS-CLIP-38	5/16 to 3/8 • 8 to 10 retaining clip
WS-CLIP-1258	7/16 to 5/8 • 11 to 16 retaining clip
WS-CLIP-34	11/16 to 3/4 • 17.5 to 19 retaining clip

Governor rope wedge sockets



Part Number	Size and Description inches • mm
WSY-38-GOV	3/8 • 10 wedge socket, wedge and 2 retaining clips, 14 mm mounting hole
WSY-12-GOV	1/2 • 13 wedge socket, wedge and 2 retaining clips, 17.5 mm mounting hole

Wire Rope Accessories

To meet ASME A17.1/CSA B44



Rope isolation bushing springs - assemblies and components

Part Number	Size and Description inches • mm	Spring Length [†] nom inches • mm	Spring O.D. nom inches • mm	Spring I.D. nom inches • mm
WS-SA-38*	5/16 to 3/8 • 8 to 10 complete assembly	4-13/16 • 122	1-5/16 • 33	11/16 • 17
WS-SA-12-A*	7/16 to 1/2 • 11 to 13 complete assembly	6-1/8 • 156	1-15/16 • 49	1 • 25
WS-SA-58*	9/16 to 5/8 • 14 to 16 complete assembly	6-7/8 • 175	2-1/2 • 64	1-1/4 • 32
WS-SA-34*	11/16 to 3/4 • 17.5 to 19 complete assembly	7-1/16 • 179	3-11/32 • 85	2-9/16 • 65
WS-IBUSH-38	5/16 to 3/8 • 8 to 10 bushing	-	-	-
WS-IBUSH-12-A	7/16 to 1/2 • 11 to 13 bushing	-	-	-
WS-IBUSH-58	9/16 to 5/8 • 14 to 16 bushing	-	-	-
WS-IBUSH-34	11/16 to 3/4 • 17.5 to 19 bushing	-	-	-
WS-SPR-38	5/16 to 3/8 • 8 to 10 bushing spring	4-13/16 • 122	1-5/16 • 33	11/16 • 17
WS-SPR-12	7/16 to 1/2 • 11 to 13 bushing spring	6-1/8 • 156	1-15/16 • 49	1 • 25
WS-SPR-58	9/16 to 5/8 • 14 to 16 bushing spring	6-7/8 • 175	2-1/2 • 64	1-1/4 • 32
WS-SPR-34	11/16 to 3/4 • 17.5 to 19 bushing spring	7-1/16 • 179	3-11/32 • 85	2-9/16 • 65
WS-BUSH-38	5/16 to 3/8 • 8 to 10 bushing washer	-	-	-
WS-BUSH-12-A	7/16 to 1/2 • 11 to 13 bushing washer	-	-	-
WS-BUSH-58	9/16 to 5/8 • 14 to 16 bushing washer	-	-	-
WS-BUSH-34	11/16 to 3/4 • 17.5 to 19 bushing washer	-	-	-

*Each isolation bushing spring assembly includes 1 spring, 3 bushings and 2 washers. The wedge socket is NOT included.

[†]Spring measured when relaxed.

Component Specifications:

Socket: Cast steel ASTM-A27, Grade 60-30 stress relieved

Rod: Rolled or forged steel ASTM 668

Wedge: Cast steel ASTM-A27, Grade 60-30

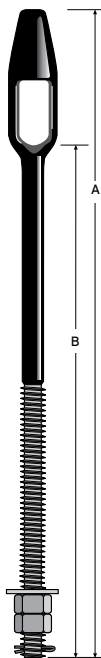

Babbitt sockets

Part Number	Rope Size inches • mm	Dim (A) nom inches • mm	Dim (B) nom inches • mm	Metric Thread
BSY-12-12	1/2 • 13	18 • 457	12 • 305	M20
BSY-12-18	1/2 • 13	24 • 610	18 • 457	M20
BSY-12-24	1/2 • 13	30 • 762	24 • 610	M20
BSY-58-12	5/8 • 16	19 • 483	12 • 305	M24
BSY-58-18	5/8 • 16	25 • 635	18 • 457	M24
BSY-58-24	5/8 • 16	31 • 787	24 • 610	M24

All Babbitt sockets are special order and are not normally stocked.

Component Specifications:

Socket: Forged carbon steel per JIS S35C or S38C equivalent to SAE 1035 or 1038, hot forged then normalized and tempered

Hex nuts: ASTM A563 Grade O

Cotter pin: Steel, per ANSI B5.20

Wire Rope Accessories



DrakaLube™ wire rope treatment/lubricant

Part Number	Description
WR-DRAKALUBE	DrakaLube wire rope treatment/lubricant, 1 gallon • 3.785 liter jug

DrakaLube wire rope treatment/lubricant has been specifically formulated for use with all types and brands of elevator wire rope. DrakaLube penetrates the rope core and contains additives that fight bending stresses, high groove pressures, friction, wear and corrosion. Most importantly, it can also displace moisture in the rope core.



Gustav Wolf T 86™ wire rope lubricant

Part Number	Description
80-4500T8601	Gustav Wolf wire rope lubricant, 0.264 gallon • 1 liter bottle

T 86 lubricant is a low-viscosity fluid which absorbs readily into the rope interior. It contains solvent (the flash point is 140° F • 60° C before the evaporation of the solvent and 455° F • 235° C after the evaporation of the solvent). Approximately 50% of the lubricant remains in the rope after evaporation of the solvent. For T 86 safe handling instructions, refer to the associated MSDS information available at www.gustav-wolf.com. T 86 is supplied in a handy one liter applicator bottle.

Rope oilers

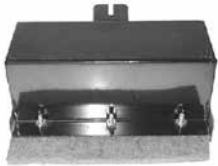

Part Number	Description
MIS-100	Automatic rope oiler, with 9 in • 229 mm wick
MIS-102	Automatic rope oiler, with 12 in • 305 mm wick
MIS-103	Extension bracket, for rope oiler
MIS-103A	Replacement wick, for all size rope oilers
MIS-103B	Replacement wick, 1/2 x 6 1/2 x 12 in • 12.7 x 165 x 305 mm

The automatic rope oiler is NOT recommended for use with T 86 rope lubricant.

Reeving splices - for right lay ropes only



Part Number	Color Code	For Rope Diameter inches • mm	Length inches • mm	Rod Diameter inches • mm	Max. Working Load lbs • kg
RS-2103	Yellow	3/8 • 9.5	22 • 559	.051 • 1.3	300 • 136
RS-2105	Orange	1/2 • 12.7	29 • 736	.070 • 1.8	2000 • 907
RS-2107	Black	5/8 • 15.9	36 • 914	.086 • 2.2	2000 • 907

Reeving splices are provided three to a package. Use ONCE and then discard. Other sizes are available.

Cable bands



Part Number	For Rope Diameter inches • mm	Quantity in Package
WR-CB-38	3/8 • 9.5	50
WR-CB-12	1/2 • 12.7	50
WR-CB-58	5/8 • 15.9	50

Wire rope clips - malleable iron



Part Number	For Rope Diameter inches • mm
79-107	1/8 • 3.2
79-114	3/16 • 4.8
79-122	1/4 • 6.4
79-123	3/8 • 9.5
79-126	1/2 • 12.7
79-127	5/8 • 15.9

Selector/hoistway door relating cable - preformed, flexible and zinc-coated



Part Number	Diameter inches • mm	Stranding	Min. Breaking Force lbf • kgf	Net Weight lbs/kft • kg/km
040219	1/16 • 1.6	7 x 7	480 • 218	7.5 • 11
040218	3/32 • 2.4	7 x 7	920 • 418	16 • 24
040215	1/8 • 3.2	7 x 19	2000 • 907	29 • 43
040216	5/32 • 4.0	7 x 19	2800 • 1270	45 • 67
040220	3/16 • 4.8	7 x 19	4200 • 1905	65 • 97
040225	1/4 • 6.4	7 x 19	7000 • 3175	110 • 164

Do NOT use selector/hoistway door relating cable for hoisting applications.

Wire Rope Tools

Tension measuring



RTS Rope Tensioning System

portable, mounts on individual ropes above car or counterweight

Part Number	Description
WR-RTS	Control unit for RTS rope tensioning system, includes LCD touch-screen operation with built-in power supply, USB cable for PC connection, T-handle allen wrench (for attaching sensors to ropes), six (6) sensors and hard-shell carrying case
WR-WRS	Wire rope sensor for RTS system, additional sensor and couplings for rope diameters of 1/6 in • 4 mm to 5/8 in • 16 mm, order one per rope from 7 up to a maximum of 12 per control unit (six sensors are included with part number WR-RTS)

The RTS (Rope Tensioning System) is a portable electronic device for quickly and accurately measuring the tension of elevator wire ropes within an accuracy of 3%. The system includes a LCD touch-screen control unit with a capacity of up to 12 sensors attached via USB connections (six sensors are included with part number WR-RTS).

In the Weighing Mode, the individual rope tension readings and average weight are shown graphically and numerically in either imperial or metric units for up to 12 ropes. The clearly displayed tension information allows the field technician to quickly and accurately equalize the rope tensions. Since the information is displayed in real time for each rope, the impact of a tensioning adjustment made to one rope is immediately visible on the other ropes.

In the Adjust Mode, the before and after tension values for up to 150 installations can be stored in the internal memory. This information can then be downloaded to a PC via the included USB cable.

Coupling hardware for each sensor is included which permits the sensors to be attached to rope diameters of 1/6 in • 4 mm to 5/8 in • 16 mm. Each sensor has a maximum capacity of 2400 lbs • 1200 kg.

The weight of the cab and counterweight can also be conveniently and precisely measured with the RTS.

Features

- Portable
- Readout in both pounds and kilograms
- Accurate to within 3%
- Can measure up to 12 ropes at once with a maximum weight of 2400 lbs • 1200 kg per rope
- Both graphic and numeric displays
- Fits 1/6 in • 4 mm to 5/8 in • 16 mm ropes
- Display languages include English, Spanish, German, Italian, French and Portuguese
- Comes with all cables, T-handled allen wrench and a hard-shell case
- Six sensors are included, with a capacity of up to 12 sensors
- Stores and downloads to PC pre- and post-tensioning values
- Low battery indicator
- Factory reset switch

Heavy duty RTS Rope Tensioning System

similar to RTS above but for higher-capacity elevators with larger hoist ropes



Part Number	Description
WR-RTS-A	Control unit for heavy duty RTS rope tensioning system, includes LCD touch-screen operation with built-in power supply, USB cable for PC connection, T-handle allen wrench (for attaching sensors to ropes), six (6) sensors and hard-shell carrying case
WR-WRS-A	Wire rope sensor for heavy duty RTS system, additional sensor and couplings for rope diameters of 1/2 in • 13 mm to 3/4 in • 20 mm, order one per rope from 7 up to a maximum of 12 per control unit (six sensors are included with part number WR-RTS-A)

The heavy duty version of the RTS is for higher-capacity elevators with larger hoist ropes. It has all of the features of the standard RTS but with a sensor that fits 1/2 in • 13 mm to 3/4 in • 20 mm ropes. Each sensor has a maximum capacity of 6600 lbs • 3000 kg.

Features

- Similar to RTS above, except can measure up to 12 ropes at once with a maximum weight of 6600 lbs • 3000 kg per rope
- Fits 1/2 in • 13 mm to 3/4 in • 20 mm ropes

Wire Rope Tools

Tension/diameter measuring and cutting

Quick-Balance tension meter



Part Number	Description
-------------	-------------

WR-QBTM-2 Wire rope tension measurement meter, 10000 lbf/45000 kgf/45000 N capacity

The Quick-Balance tension meter can be attached to a rope, used to measure tension, and removed in just seconds. In the Balance Mode the load on each rope can be adjusted to equalize tensioning across all ropes. The device also allows a single field technician to determine the weight of the elevator and counterweight in minutes. The digital load cell assures accuracy of up to +/- 3% when calibrated to the specific rope size and type.

The meter is shipped from the factory with 1/2 in • 12.7 mm, 9/16 in • 14.3 mm and 5/8 in • 15.9 mm diameter calibrations (other diameters are available by special order). The standard sheave set accommodates rope diameters of 1/4 in • 6.4 mm through 3/4 in • 19 mm. A hard-shell carrying case is included.



Digital caliper

Part Number	Description
-------------	-------------

WR-CALIPER-C Digital wire rope caliper, imperial and metric scales, includes special jaws for ease of use and a hard-shell carrying case



Measuring tool - conforms to ASME A17.6 standard

Part Number	Description
-------------	-------------

WR-MT Wire rope measuring gauge, for imperial diameters, go/no go style, 3/8, 7/16, 1/2, 9/16, 5/8, 11/16 and 3/4 in

WR-MT-METRIC Wire rope measuring gauge, for metric diameters, go/no go style, 6, 8, 10, 11, 12, 13, 16 and 19 mm

Convenient machined-aluminum tool for quick and accurate measurement of wire rope diameters. If the rope fits in the groove, or if a rope with rouge fits the stepped groove, retire the rope.



Impact-style rope cutter

Part Number	Description
-------------	-------------

WR-IMPACT Impact-style wire rope cutter, Morse-Starrett 101, for diameters up to 3/4 in • 19 mm



Hydraulic-style rope cutter

Part Number	Description
-------------	-------------

WR-HYDRAULIC Hydraulic-style wire rope cutter, Morse-Starrett W-075, for diameters up to 3/4 in • 19 mm



Ratchet-style rope cutter

Part Number	Description
-------------	-------------

WR-RATCHET Ratchet-style wire rope cutter, Cooper Tools 8690 TN, for diameters up to 3/4 in • 19 mm

20

HIGH, MID, LOW, FAST OR SLOW, GUSTAV WOLF HAS THE ROPE YOU NEED.

10

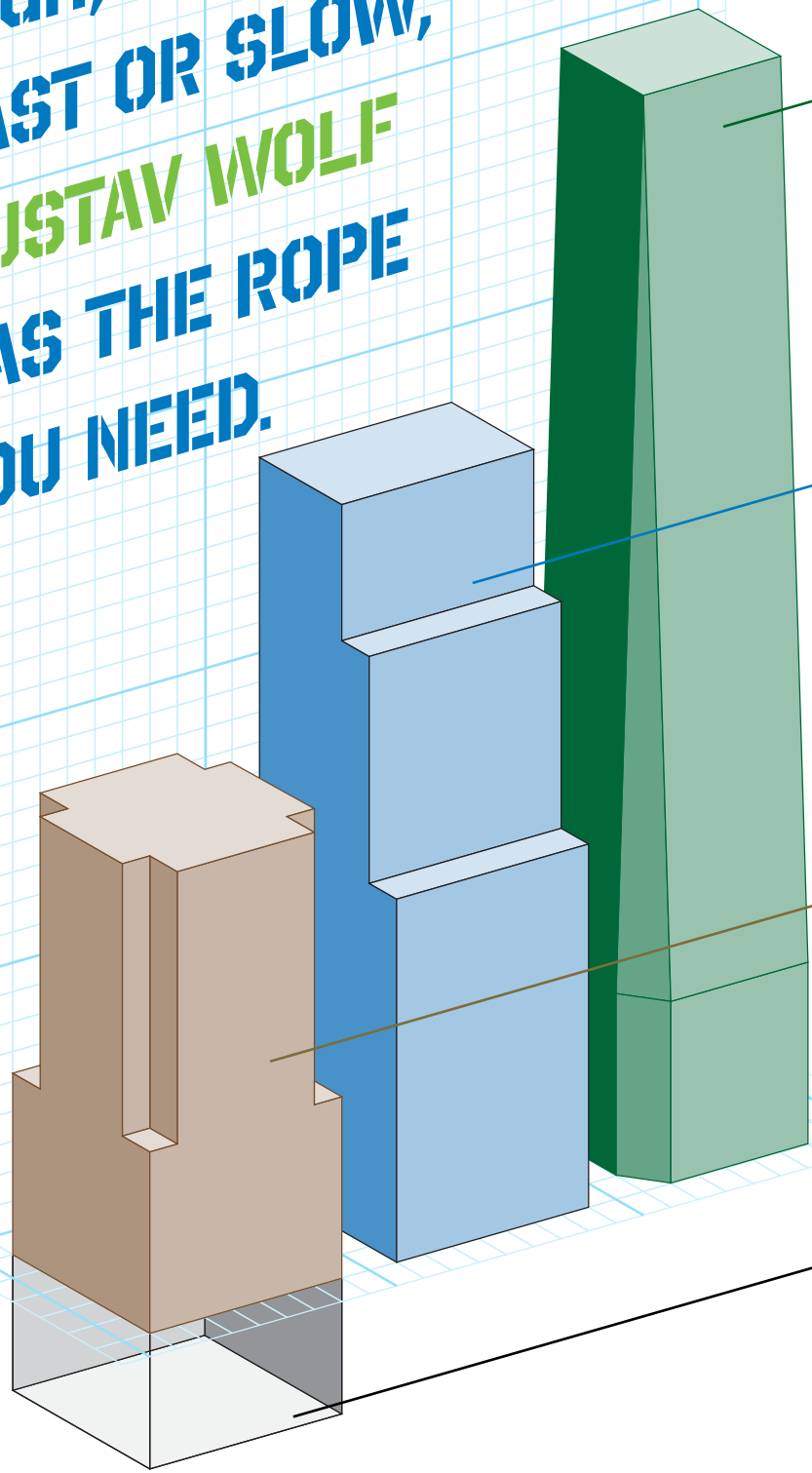

PAWO F10 for high-rise and high-speeds

PAWO F10 is designed for high-rise/high-speed elevators. Its full steel core nine-strand/filler wire design achieves the ultimate in performance.

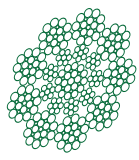

PAWO F3 for mid-rise and mid-speeds

PAWO F3 is for mid-rise/mid-speed elevators, with a steel-reinforced core that reduces/eliminates the labor cost of repeated rope shortening.

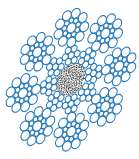

LOW-STRETCH Natural Fiber Core for low-rises

Low-Stretch, the economical low-rise choice, delivers prestretched performance without the premium price.

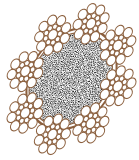

COMPACTTRAC™ for basement machines

CompactTrac™, designed for use with basement machines, uses compacted strands to extend reverse-bend rope service life.

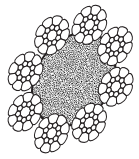

GUSTAV WOLF



www.gustav-wolf.com

Gustav Wolf wire ropes are available from:
Draka (US/Canada) 1-877-DRAKA-EP (1-877-372-5237)
Benfield (Metro NYC) 1-718-706-8600
S.E.E.S. Inc. (Florida) 1-800-526-0026
For technical support 1-919-878-5605

North American distribution locations and ordering information

United States

Draka Elevator Products

877-DRAKA-EP (877-372-5237) ☎

252-972-6001 📠

- Chicago (Schaumburg, IL)
- Houston, TX
- Los Angeles (Commerce, CA)
- Memphis (Walnut, MS)
- Metro NYC (Long Island City, NY)
- Rocky Mount, NC

Benfield Electric & Elevator Supply Corp.

718-706-8600 ☎

718-706-8665 📠

- Metro NYC (Bronx, NY)

S.E.E.S., Inc./ Southern Elevator & Electric Supply

800-526-0026 ☎

954-917-7337 📠

- Pompano Beach, FL

Canada

Draka Elevator Products

877-DRAKA-EP (877-372-5237) ☎

252-972-6001 📠

- Calgary, AB
- Edmonton, AB
- Toronto (Brantford, ON)
- Vancouver, BC

Mexico

Draka Elevator Products

252-972-6000 ☎

252-972-6001 📠

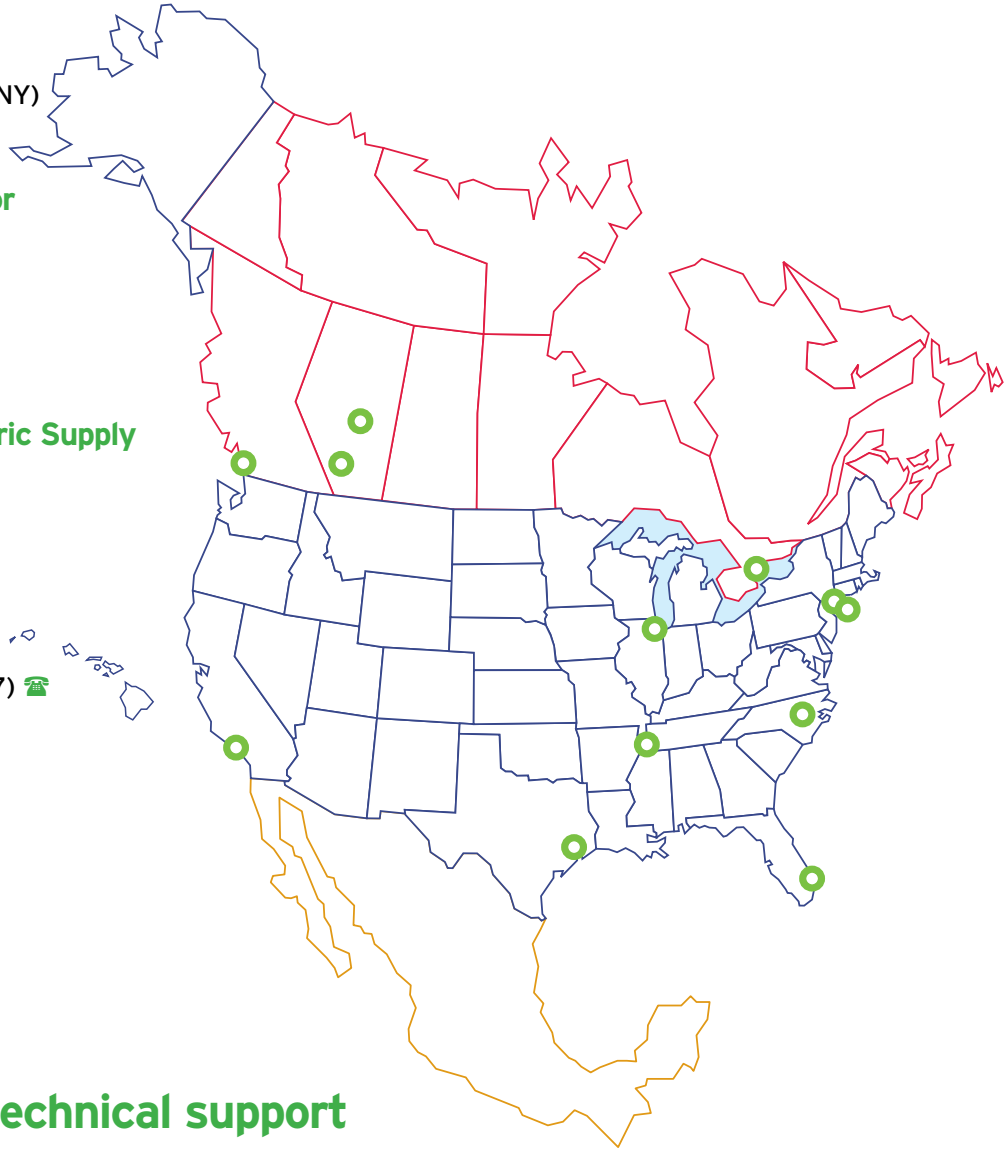

North American technical support

Gustav Wolf

Richard L. Lindemeyer

General Manager - North America

919-878-5605 ☎ 📠

richard.lindemeyer@gustav-wolf.com

www.gustav-wolf.com



GUSTAV WOLF

